

# Rider's Manual

## R 1200 ST



BMW Motorrad



The Ultimate Riding  
Machine

## Motorcycle data/dealership details

### Motorcycle data

---

Model

---

Vehicle identification number

---

Colour code

---

Date of first registration

---

Registration number

### Dealership details

---

Person to contact in Service department

---

Ms/Mr

---

Phone number

---

Dealership address/phone number (company stamp)

## **Welcome to BMW**

We congratulate you on your choice of a motorcycle from BMW and welcome you to the community of BMW riders. Familiarise yourself with your new motorcycle so that you can ride it safely and confidently in all traffic situations.

Please read this Rider's Manual carefully before starting to use your new BMW motorcycle. It contains important information on how to operate the controls and how to make the best possible use of all your BMW's technical features.

In addition, it contains information on maintenance and care to help you maintain your motorcycle's reliability and safety, as well as its value.

If you have questions concerning your motorcycle, your authorised

BMW Motorrad dealer will gladly provide advice and assistance.

We hope that you will enjoy riding your BMW and that all your journeys will be pleasant and safe.

BMW Motorrad.

# Table of Contents

You can also consult the index at the end of this Rider's Manual if you want to find a particular topic or item of information.

## **1 General instructions ..... 5**

Overview .....	6
Abbreviations and symbols ....	6
Equipment .....	7
Technical data .....	7
Currency .....	7

## **2 General views ..... 9**

General view, left side .....	11
General view, right side .....	13
Underneath the seat .....	15
Handlebar fitting, left .....	16
Handlebar fitting, right .....	17
Instrument cluster .....	18
Headlight .....	19

## **3 Status indicators ..... 21**

Standard status indicators .....	22
Status indicators with on-board computer <sup>OE</sup> .....	23
Status indicators with tyre-pressure monitoring (RDC) <sup>OE</sup> .....	24
Standard warnings .....	24
Warnings issued by the on-board computer <sup>OE</sup> .....	28
ABS warnings <sup>OE</sup> .....	30
ASC warnings <sup>OE</sup> .....	32
RDC warnings <sup>OE</sup> .....	34
Anti-theft alarm warnings <sup>OE</sup> .....	39

## **4 Operation ..... 43**

Ignition switch and steering lock .....	44
Electronic immobiliser (EWS) .....	45
Clock .....	46
Odometer and tripmeters ....	47
On-board computer <sup>OE</sup> .....	50

Tyre pressure monitoring RDC <sup>OE</sup> .....	53
Lights .....	54
Turn indicators .....	55
Hazard warning flashers .....	56
Emergency off switch (kill switch) .....	57
Grip heating <sup>OE</sup> .....	57
Automatic Stability Control ASC <sup>OE</sup> .....	58
Seat height .....	59
Windscreen .....	59
Clutch .....	60
Brakes .....	60
Mirrors .....	61
Handlebars .....	62
Spring preload .....	62
Damping .....	63
Electronic Suspension Adjustment ESA <sup>OE</sup> .....	64
Tyres .....	66
Headlight .....	67
Front and rear seats .....	68
Helmet holder .....	70

<b>5 Riding</b> .....	<b>71</b>	<b>8 Maintenance</b> .....	<b>99</b>	Restoring motorcycle to use .....	134
Safety instructions .....	72	General instructions .....	100	<b>10 Technical data</b> .....	<b>135</b>
Checklist .....	73	Toolkit.....	100	Troubleshooting chart.....	136
Starting.....	74	Engine oil .....	101	Threaded fasteners .....	137
Running in .....	77	Brake system, general.....	103	Engine .....	139
Brakes .....	77	Brake pads .....	103	Fuel .....	140
Parking your motorcycle .....	79	Brake fluid.....	105	Engine oil .....	140
Refuelling .....	80	Clutch .....	107	Clutch .....	141
<b>6 Engineering details</b> .....	<b>83</b>	Tyres .....	108	Transmission .....	142
Brake system with BMW Motorrad Integral ABS <sup>OE</sup> .....	84	Rims .....	109	Rear-wheel drive .....	142
Electronic engine management with BMW Motorrad ASC <sup>OE</sup> .....	86	Wheels .....	109	Running gear.....	143
Tyre pressure monitoring RDC <sup>OE</sup> .....	88	Front-wheel stand.....	116	Brakes .....	144
<b>7 Accessories</b> .....	<b>91</b>	Rear-wheel stand .....	118	Wheels and tyres.....	144
General instructions .....	92	Bulbs .....	118	Electrics .....	146
Power socket .....	92	Jump starting .....	126	Frame .....	148
Luggage .....	93	Battery .....	127	Dimensions .....	148
Case <sup>OA</sup> .....	94	<b>9 Care</b> .....	<b>131</b>	Weights .....	149
Topcase <sup>OA</sup> .....	96	Care products .....	132	Riding specifications .....	149
		Washing motorcycle.....	132		
		Cleaning easily damaged components.....	132		
		Paint care .....	133		
		Protective wax coating .....	134		
		Laying up the motorcycle .....	134		

<b>11 Service .....</b>	<b>151</b>
BMW Motorrad service.....	152
BMW Motorrad service quality .....	152
BMW Motorrad Service Card: on-the-spot break- down assistance .....	152
BMW Motorrad service net- work.....	153
Maintenance work.....	153
Confirmation of mainten- ance work .....	154
Confirmation of service.....	159

## General instructions

Overview .....	6
Abbreviations and symbols .....	6
Equipment .....	7
Technical data .....	7
Currency .....	7

## Overview

Chapter 2 of this Rider's Manual will provide you with an initial overview of your motorcycle. All maintenance and repair work on the motorcycle is documented in Chapter 11. This record of the maintenance work you have had performed on your motorcycle is a precondition for generous treatment of goodwill claims.

When the time comes to sell your BMW, please remember to hand over this Rider's Manual; it is an important part of the motorcycle.

## Abbreviations and symbols



Indicates warnings that you must comply with for reasons of your safety and the safety of others, and to protect your motorcycle against damage.



Specific instructions on how to operate, control, adjust or look after items of equipment on the motorcycle.



Indicates the end of an item of information.



Instruction.



Result of an activity.



Reference to a page with more detailed information.



Indicates the end of a passage relating to specific accessories or items of equipment.



Tightening torque.



Item of technical data.

**OE** Optional extra  
The motorcycles are assembled complete with all the BMW optional extras originally ordered.

**OA** Optional accessory  
You can obtain optional accessories through your authorised BMW Motorrad dealer; optional accessories have to be retrofitted to the motorcycle.

**EWS** Electronic immobiliser (Elektronische Wegfahrsicherung).

**DWA** Anti-theft alarm (Diebstahlwarnanlage)

**ABS** Anti-lock brake system

**ASC** Automatic Stability Control.

RDC Tyre pressure control  
(ReifenDruck-Control)

ESA Electronic Suspension  
Adjustment  
Electronic Suspension  
Adjustment.

## Equipment

When you ordered your BMW motorcycle, you chose various items of custom equipment. This Rider's Manual describes optional extras (OE) offered by BMW and selected optional accessories (OA). This explains why the manual may also contain descriptions of equipment which you have not ordered. Please note, too, that your motorcycle might not be exactly as illustrated in this manual on account of country-specific differences. If your BMW was supplied with equipment not described in this Rider's Manual, you will

find these features described in separate manuals.

## Technical data

All dimensions, weights and power ratings stated in the Rider's Manual are quoted to the standards and comply with the tolerance requirements of the Deutsche Institut für Normung e.V. Versions for individual countries may differ.

## Currency

The high safety and quality standards of BMW motorcycles are maintained by constant development work on designs, equipment and accessories. Because of this, your motorcycle may differ from the information supplied in the Rider's Manual. Nor can BMW Motorrad entirely rule out errors and omissions. We hope you will appreciate that no claims can be entertained on

the basis of the data, illustrations or descriptions in this manual.



## General views

General view, left side.....	11
General view, right side .....	13
Underneath the seat .....	15
Handlebar fitting, left .....	16
Handlebar fitting, right .....	17
Instrument cluster .....	18
Headlight .....	19

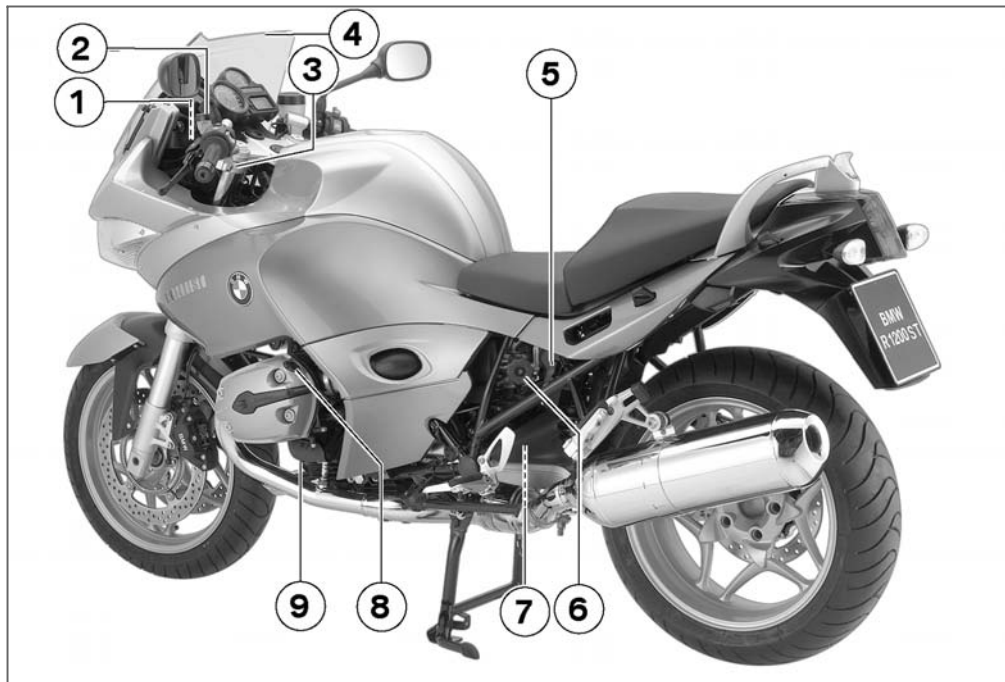

## General view, left side

- 1 Headlight beam-throw adjustment (➡ 67)
- 2 Clutch-fluid reservoir (➡ 107)
- 3 Adjuster for handlebar height (➡ 62)
- 4 Adjustable windscreen (➡ 59)
- 5 Power socket (➡ 92)
- 6 Adjuster for spring preload, rear (➡ 62)
- 7 Adjuster for damping characteristic, rear suspension (➡ 63)
- 8 Engine-oil filler neck (➡ 102)
- 9 Oil sight glass (➡ 101)



## General view, right side

- 1 Seat lock (100 68)
- 2 Brake-fluid reservoir, rear (100 106)
- 3 Vehicle identification number
- 4 Brake-fluid reservoir, front (100 103)
- 5 Case holders<sup>OA</sup> (100 95)

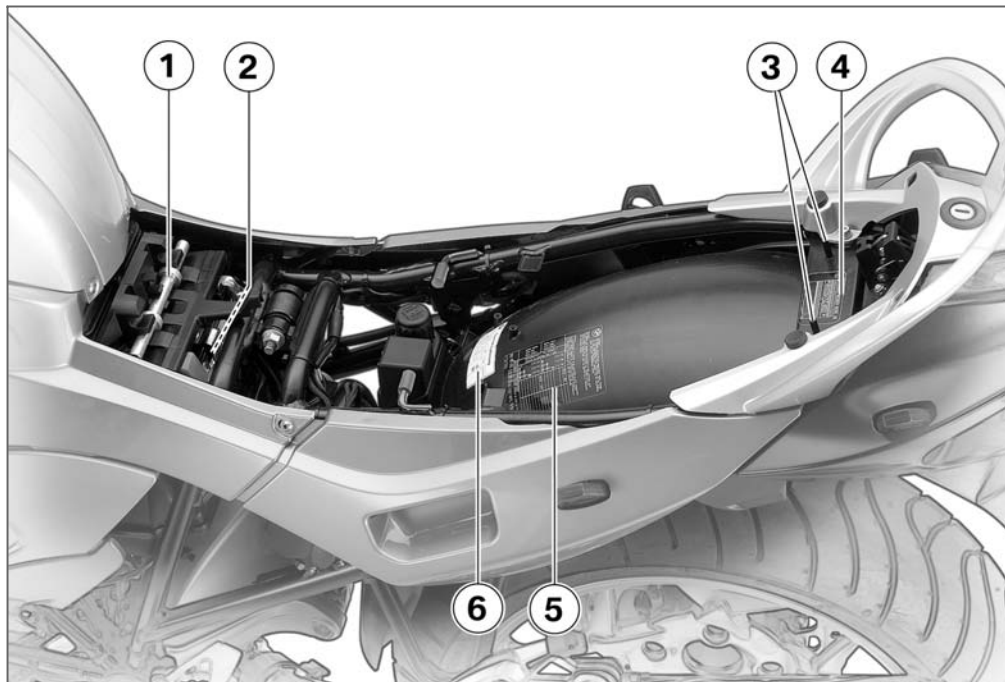

## Underneath the seat

- 1 Front-seat height adjustment (→ 59)
- 2 Battery (→ 127)
- 3 Helmet holder (→ 70)
- 4 Type plate
- 5 Table of tyre pressures
- 6 Sign for payload

## Handlebar fitting, left

- 1 Operating the odometer (➡ 47), Operating the on-board computer<sup>OE</sup> (➡ 50)
- 2 Operating ASC<sup>OE</sup> (➡ 58)
- 3 Operating the ESA<sup>OE</sup> (➡ 64)
- 4 Horn
- 5 Flashing turn indicators, left (➡ 55), Hazard warning flashers (➡ 56)
- 6 Headlight flasher and high-beam headlight (➡ 54)



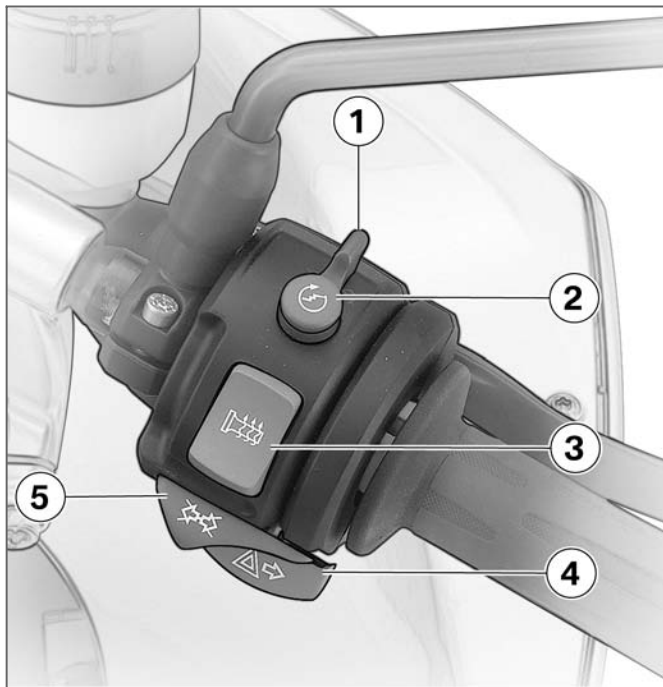

## Handlebar fitting, right

- 1 Emergency off switch (kill switch) (➔ 57)
- 2 Starter button (➔ 74)
- 3 Grip heating<sup>OE</sup> (➔ 57)
- 4 Flashing turn indicators, right (➔ 55), Hazard warning flashers (➔ 56)
- 5 Cancel button, flashing turn indicators (➔ 56), Pushbutton, cancel hazard warning flashers (➔ 56)

## Instrument cluster

- 1 Speedometer
- 2 Rev. counter
- 3 Telltale lights (➡ 22)
- 4 Multifunction display (➡ 22)
- 5 Telltale light, anti-theft alarm (OE) and sensor for instrument lighting
- 6 Select readings (➡ 47)  
Reset the tripmeter (➡ 48)  
Set the clock (➡ 46)

▶ The instrument-cluster lighting has automatic day and night switchover. ◀

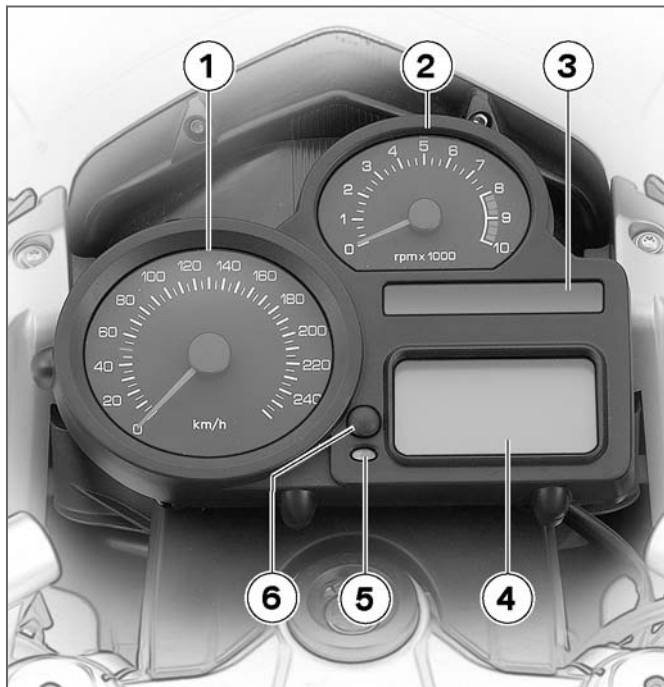

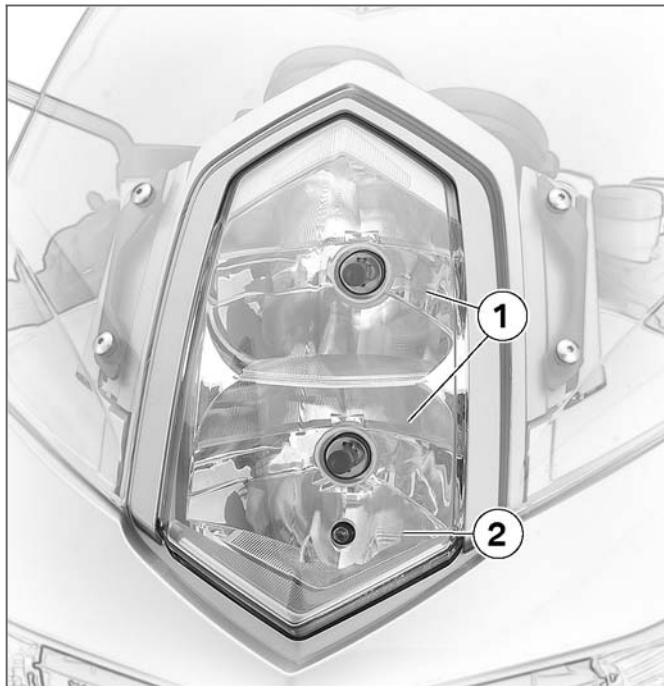

## Headlight

- 1 Low-beam and high-beam headlights (→ 54)
- 2 Side light (→ 54)



## Status indicators

Standard status indicators .....	22
Status indicators with on-board computer <sup>OE</sup> .....	23
Status indicators with tyre-pressure monitoring (RDC) <sup>OE</sup> .....	24
Standard warnings .....	24
Warnings issued by the on-board computer <sup>OE</sup> .....	28
ABS warnings <sup>OE</sup> .....	30
ASC warnings <sup>OE</sup> .....	32
RDC warnings <sup>OE</sup> .....	34
Anti-theft alarm warnings <sup>OE</sup> .....	39

## Standard status indicators

### Multifunction display

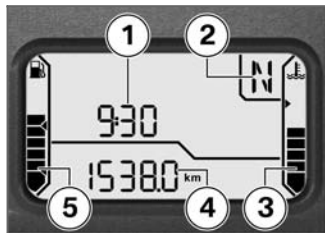

- 1 Clock (➡ 46)
- 2 Gear indicator (➡ 22)
- 3 Engine temperature (➡ 22)
- 4 Odometer and tripmeters (➡ 47)
- 5 Fuel capacity (➡ 22)

## Telltale lights



- 1 Flashing turn indicators, left
- 2 High-beam headlight
- 3 Idle
- 4 Flashing turn indicators, right

## Fuel capacity

 The horizontal bars below the fuel-pump symbol indicate the remaining quantity of fuel.

When the fuel in the tank is topped up the gauge briefly shows the original level, before the reading is updated.

## Gear indicator

 The gear engaged or **N** for neutral appears on the display.

 If no gear is engaged, the 'neutral' telltale light also lights up.

## Engine temperature

 The horizontal bars below the temperature symbol indicate the engine temperature.

## Service-due indicator



If the next service is due in less than one month, the date for the

next service is shown briefly after the Pre-Ride Check completes. Month and year are both shown as two-digit numbers with a line as separator, so in this example the next service is due in March 2007.



If the motorcycle covers long distances in the course of the year, under certain circumstances it might be necessary to have it serviced at a date in advance of the forecast due date. If the countdown distance to the odometer reading at which a service will be due is less than 1000 km,

the distance is counted down in steps of 100 km and is shown briefly after the Pre-Ride Check completes.

If service is overdue, the date or the odometer reading is accompanied by the 'General' warning light showing yellow. The word "Service" remains permanently visible.

▶ If the service-due indicator appears more than a month in advance of the actual due date or if the word "Service" does not show permanently even though a service is overdue, the date stored in memory in the instrument cluster is incorrect and must be set. This situation can occur if the battery was disconnected for a prolonged period of time.

If you want to have the date set consult a specialist workshop,

preferably an authorised BMW Motorrad dealer. ◀

## Status indicators with on-board computer<sup>OE</sup>



- 1 Status-indicator panel of the on-board computer<sup>OE</sup> (→ 50)

## Status indicators with tyre-pressure monitoring (RDC)<sup>OE</sup>



- 1** Tyre pressures alternate with the clock; if the motorcycle is fitted with an on-board computer tyre pressures displayed as an additional set of readings by the on-board computer.<sup>OE</sup> (→ 53)

## Standard warnings











### Mode of presentation



Warnings are indicated by the 'General' warning light **1** showing in combination with a warning word, for example **2** or in combination with one of the warning symbols **3**. The 'General' warning light shows red or yellow, depending on the urgency of the warning. If two or more warnings occur at the same time, all the appropriate warning lights and warning symbols appear, alternating with warning words as applicable.

The possible warnings are listed on the next page.

## Warnings, overview

			Meaning
	Lights up yellow	EWS ! appears on the display.	Electronic immobiliser active (➡ 26)
	Lights up yellow	FUEL ! appears on the display.	Fuel down to reserve (➡ 26)
	Lights up yellow	 Appears on the display	Engine in emergency-operation mode (➡ 26)
	Flashes red	 Appears on the display	Insufficient engine oil pressure (➡ 26)
	Lights up red	 Appears on the display	Insufficient battery charge current (➡ 27)
	Lights up yellow	LAMP R ! appears on the display.	Rear light bulb defective (➡ 27)
		LAMP F ! appears on the display.	Front light bulb defective (➡ 28)
	Lights up yellow	LAMP S ! appears on the display.	Bulbs defective (➡ 28)

### Electronic immobiliser active

 General warning light shows yellow.

**EWS !** appears on the display. The key being used is not authorised for starting, or communication between key and engine electronics is disrupted.

- Remove all other vehicle keys from the same ring as the ignition key.
- Use the reserve key.
- Have the defective key replaced, preferably by an authorised BMW Motorrad dealer.

### Fuel down to reserve

 General warning light shows yellow.

**FUEL !** appears on the display.

 Lack of fuel can result in the engine misfiring and cutting out unexpectedly. Misfiring can damage the catalytic converter; a hazardous situation

can result if the engine cuts out unexpectedly.

Do not run the fuel tank dry. ◀

The fuel tank contains no more than the reserve quantity of fuel.

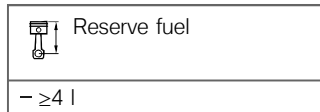

- Refuelling (  80 )

### Engine in emergency-operation mode

 General warning light shows yellow.

 Engine symbol appears on the display.

 The engine is running in emergency operating mode. Engine power might be reduced and this can cause hazardous situations, particularly if you attempt to overtake other road users.

Engine power level might be lower than normal: adapt your style of riding accordingly. ◀

The engine control unit has diagnosed a fault. In exceptional cases, the engine stops and refuses to start. Otherwise, the engine runs in emergency operating mode.

- You can continue to ride, but bear in mind that the usual engine power might not be available.
- Have the fault rectified as quickly as possible by a specialist workshop, preferably an authorised BMW Motorrad dealer.

### Insufficient engine oil pressure

 General warning light flashes red.



Oil-can symbol appears on the display.

The oil pressure in the lube-oil system is too low. Stop immediately and switch off the engine.



The insufficient oil pressure warning does not fulfil the function of an oil gauge. The only way of checking whether the oil level is correct is to check the oil sight glass. ◀

A low oil level is one reason why a warning indicating insufficient oil pressure is issued.

- Check the engine oil level (→ 101)

If the oil level is too low:

- Top up the engine oil.

If the engine oil level is correct:



Riding when engine-oil pressure is low can result in engine damage.

Do not continue your journey. ◀

- Have the fault rectified as quickly as possible by a specialist workshop, preferably an authorised BMW Motorrad dealer.

### Insufficient battery charge current



General warning light shows red.



Battery symbol appears on the display.



A discharged battery can cause the engine to die suddenly, and this could result in a dangerous situation in traffic. Have faults rectified as soon as possible. ◀



If the battery is not charging, continuing to ride can cause it to discharge completely, in which case it will suffer irreparable damage. If possible, do not continue your journey. ◀

Battery is not being charged.

- You can continue to ride until the battery is discharged. Bear in mind, however, that the engine could cut out suddenly and that the battery could discharge until completely flat, in which case it might have suffered irreparable damage.
- Have the fault rectified as quickly as possible by a specialist workshop, preferably an authorised BMW Motorrad dealer.

### Rear light bulb defective



General warning light shows yellow.

LAMP R ! appears on the display.



A defective bulb places your safety at risk because it is easier for other users to oversee the motorcycle. Replace defective bulbs as

soon as possible; always carry a complete set of spare bulbs if possible. ◀

Rear light or brake light bulb defective.

- Replacing the brake light and rear light bulbs (➡ 122)

### Front light bulb defective

LAMPF ! appears on the display.

 A defective bulb places your safety at risk because it is easier for other users to oversee the motorcycle. Replace defective bulbs as soon as possible; always carry a complete set of spare bulbs if possible. ◀

Low-beam headlight, high-beam headlight, side-light or turn-indicator bulb defective.

- Replacing low-beam and high-beam headlight bulbs (➡ 119)

- Replacing parking-light bulb (➡ 121)
- Replacing front turn indicator bulb (➡ 123)
- Replacing rear turn indicator bulb (➡ 125)

### Bulbs defective

 General warning light shows yellow.

LAMPS ! appears on the display.

 A defective bulb places your safety at risk because it is easier for other users to oversee the motorcycle. Replace defective bulbs as soon as possible; always carry a complete set of spare bulbs if possible. ◀

A combination of the bulb defects described above has occurred.

- See the fault descriptions above.

## Warnings issued by the on-board computer<sup>OE</sup>

### Mode of presentation

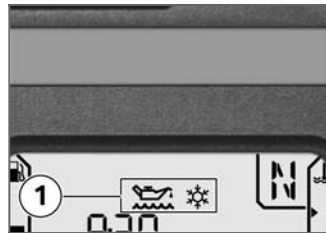

Warnings issued by the on-board computer appear in panel **1**. The possible warnings are listed on the next page.

## Warnings, overview

### Meaning



Appears on the display

Engine-oil level too low (  30)

Check Oil appears on the display.



Appears on the display

Ice warning (  30)

## Engine-oil level too low



Oil-level symbol appears on the display.

Check Oil appears on the display.

The electronic oil-level sensor has registered an excessively low oil level.

The only exact way of checking whether the oil level is correct is to check the oil sight glass. The next time you stop for fuel:

- Check the engine oil level (▬▬▬ 101)

If the oil level is too low:

- Top up the engine oil (▬▬▬ 102)

The oil sensor might be defective if the "Check oil level" message appears even though a check at the oil sight glass reveals that the oil level is correct.

- Seek the advice of a specialist workshop, preferably an authorised BMW Motorrad dealer.

## Ice warning



Ice-crystal symbol appears on the display.

The air temperature measured at the motorcycle is lower than 3 °C.



The ice warning does not mean that there is no risk of black ice forming at measured temperatures above 3 °C.

Always take extra care and think well ahead when temperatures are low; remember that the danger of black ice is particularly high on bridges and where the road is in the shade. ◀

- Ride carefully and think well ahead.

## ABS warnings<sup>OE</sup>

### Mode of presentation



ABS warnings are indicated by ABS warning light 1.

The way in which the ABS warning light indicates status can differ in some countries.



Possible national variant.

The detailed descriptions relating to BMW Motorrad Integral ABS start on page (▬▬▬ 84), and you will find an overview listing the possible warnings on the next page.

## Warnings, overview

### Meaning

---

	Flashes	Self-diagnosis not completed (→ 32)
	Lights up	ABS fault (→ 32)

---

## Self-diagnosis not completed



ABS warning light flashes.

The ABS function is not available, because self-diagnosis did not complete. The motorcycle has to move forward a few metres for the wheel sensors to be tested.

- Pull away slowly. Bear in mind that the ABS function is not available until self-diagnosis has completed.

## ABS fault



ABS warning light shows.

The ABS control unit has detected a fault. The ABS function is not available.

- You can continue to ride the motorcycle, but make due provision for the fact that the ABS function is not available. Bear in mind the more detailed in-

formation on situations that can lead to an ABS fault (➡ 85).

- Have the fault rectified as quickly as possible by a specialist workshop, preferably an authorised BMW Motorrad dealer.

page (➡ 86), and you will find an overview listing the possible warnings on the next page.

## ASC warnings<sup>OE</sup>



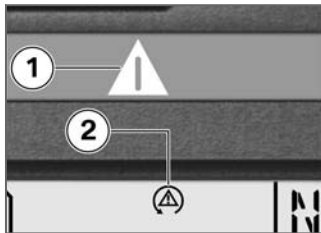



### Mode of presentation



ASC warnings are indicated by a combination of the ASC warning symbol **2** and 'General' warning light **1**.

The detailed descriptions relating to BMW Motorrad ASC start on

## Warnings, overview

		<b>Meaning</b>	
	Quick-flashes yellow		Appears on the display ASC intervention (→ 34)
			Flashes Self-diagnosis not completed (→ 34)
			Appears on the display ASC deactivated (→ 34)
	Lights up yellow		Appears on the display ASC fault (→ 34)

### ASC intervention



General warning light quick-flashes yellow.



ASC symbol appears on the display.

The ASC has detected a degree of instability at the rear wheel and has intervened to reduce torque. The warning light flashes for longer than ASC intervention lasts. This affords the rider visual feedback on control intervention even after the critical situation has been dealt with.

### Self-diagnosis not completed



ASC symbol flashes.

Self-diagnosis did not complete, so the ASC function is not available. The engine must be running and the motorcycle must reach a speed of at least 5 km/h in order for ASC self-diagnosis to complete.

- Pull away slowly. Bear in mind that the ASC function is not available until self-diagnosis has completed.

### ASC deactivated



ASC symbol appears on the display.

The rider has switched off the ASC system. with OE Automatic Stability Control:

- Activate the ASC function (➔ 58)

### ASC fault



General warning light shows yellow.



ASC symbol appears on the display.

The ASC control unit has detected a fault. The ASC function is not available.

- You can continue to ride. Bear in mind that the ASC function

is not available. Bear in mind the more detailed information on situations that can lead to an ASC fault (➔ 87).

- Have the fault rectified as quickly as possible by a specialist workshop, preferably an authorised BMW Motorrad dealer.

## RDC warnings<sup>OE</sup>

### Mode of presentation

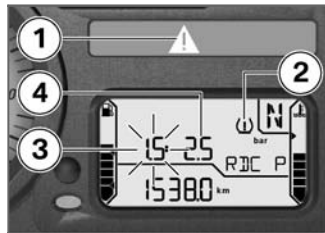







Warning symbol **2** indicates a critical tyre pressure, and the corresponding reading for the front

tyre pressure **3** or the rear tyre pressure **4** flashes.

If the critical value is close to the limit of the permissible tolerance range, 'General' warning light **1** also comes on and shows yellow. If the tyre pressure registered by the sensor is outside the permissible tolerance range, the 'General' warning light flashes red.

The detailed descriptions relating to BMW Motorrad RDC start on page (➔ 88), and you will find an overview listing the possible warnings on the next page.

## Warnings, overview

		Meaning
	Lights up yellow	 Tyre pressure close to limit of permitted tolerance (→ 37)
	the critical tyre pressure flashes.	
	Flashes red	 Tyre pressure outside permitted tolerance (→ 37)
	the critical tyre pressure flashes.	
	"--" or "-- --" appears on the display	Signal transmission disrupted (→ 37)
	Lights up yellow	 Sensor defective or system error (→ 38)
	"--" or "-- --" appears on the display	
	Lights up yellow	RDC ! appears on the display. Battery of tyre-pressure sensor weak (→ 38)

## Tyre pressure close to limit of permitted tolerance



General warning light shows yellow.



Tyre symbol appears on the display.

The critical tyre pressure flashes. Measured tyre pressure is close to the limit of permitted tolerance.

- Correct the tyre pressure as stated on the inside cover of the Rider's Manual.



The tyre-pressures listed on the inside cover are temperature-compensated; the reference tyre temperature for these readings is always 20 °C. The procedure for correcting tyre pressures when the tyres are not at this reference temperature is as follows:

Calculate the difference between the specified value stated in the Rider's Manual and the reading

shown by the RDC system. Use the public air line at a petrol station or motorway service area to adjust the tyre pressure by this amount. ◀

## Tyre pressure outside permitted tolerance



General warning light flashes red.



Tyre symbol appears on the display.

The critical tyre pressure flashes. Measured tyre pressure is outside permitted tolerance.

- Check the tyre for damage and to ascertain whether the motorcycle can be ridden with the tyre in its present condition.

If the motorcycle can be ridden with the tyre in its present condition:



Incorrect tyre pressures impair the motorcycle's handling characteristics.

If tyre pressure is incorrect it is essential to adapt your style of riding accordingly. ◀

- Correct the tyre pressure at the earliest possible opportunity.
- Have the tyre checked for damage by a specialist workshop, preferably an authorised BMW Motorrad dealer.

If you are unsure whether the motorcycle can be ridden with the tyre in its present condition:

- Do not continue your journey.
- Notify the breakdown service.
- Have the tyre checked for damage by a specialist workshop, preferably an authorised BMW Motorrad dealer.

## Signal transmission disrupted

"--" or "-- --" appears on the display.

The motorcycle has not yet accelerated past the threshold of approximately 30 km/h. The RDC sensors do not start transmitting signals until the motorcycle reaches a speed above this threshold (➡ 88).

- Increase speed above this threshold and observe the RDC readings. Assume that a permanent fault has not occurred unless the 'General' warning light comes on to accompany the symptoms. Under these circumstances:
- Have the fault rectified by a specialist workshop, preferably an authorised BMW Motorrad dealer.

Wireless communication with the RDC sensors has been disrupted. Possible causes include radio-communication systems operating in the vicinity and interfering

with the link between the RDC control unit and the sensors.

- Move to another location and observe the RDC readings. Assume that a permanent fault has not occurred unless the 'General' warning light comes on to accompany the symptoms. Under these circumstances:
- Have the fault rectified by a specialist workshop, preferably an authorised BMW Motorrad dealer.

### Sensor defective or system error



General warning light shows yellow.



Tyre symbol appears on the display.

"---" or "--- ---" appears on the display.

Motorcycle is fitted with wheels not equipped with RDC sensors.

- Fit wheels and tyres equipped with RDC sensors.

One or two RDC sensors have failed.

- Have the fault rectified by a specialist workshop, preferably an authorised BMW Motorrad dealer.

A system error has occurred.

- Have the fault rectified by a specialist workshop, preferably an authorised BMW Motorrad dealer.

### Battery of tyre-pressure sensor weak



General warning light shows yellow.

RDC ! appears on the display.

 This error message appears only briefly after the pre-ride check completes.◀

The integral battery in the tyre-pressure sensor has lost a significant proportion of its original capacity. There is no assurance of how long the tyre pressure control system can remain operational.

- Seek the advice of a specialist workshop, preferably an authorised BMW Motorrad dealer.

## Anti-theft alarm warnings<sup>OE</sup>

### Mode of presentation

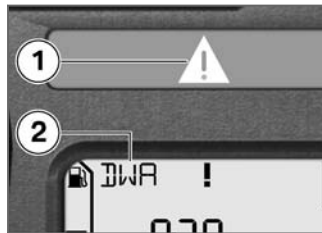



Anti-theft alarm warnings appear as plain-text warnings **2** in combination with the 'General' warning light **1** showing after the Pre-Ride Check and relate to the capacity of the internal battery that supplies power to the anti-theft alarm.

The possible warnings are listed on the next page.

## Warnings, overview

### Meaning

	DWALO ! appears on the display.	Anti-theft alarm battery weak (  41)
	Lights up yellow DWA ! appears on the display.	Anti-theft alarm battery flat (  41)

### **Anti-theft alarm battery weak**

DWALO ! appears on the display.

 This error message appears only briefly after the pre-ride check completes. ◀

The integral battery in the anti-theft alarm has lost a significant proportion of its original capacity. There is no assurance of how long the anti-theft alarm can remain operational if the motorcycle's battery is disconnected.

- Seek the advice of a specialist workshop, preferably an authorised BMW Motorrad dealer.

### **Anti-theft alarm battery flat**

 General warning light shows yellow.

DWA ! appears on the display.

 This error message appears only briefly after the pre-ride check completes. ◀

The integral battery in the anti-theft alarm has lost its entire original capacity. There is no assurance that the anti-theft alarm will be operational if the motorcycle's battery is disconnected.

- Seek the advice of a specialist workshop, preferably an authorised BMW Motorrad dealer.



## Operation

Ignition switch and steering lock . . . . .	44	Windscreen . . . . .	59
Electronic immobiliser (EWS) . . . . .	45	Clutch . . . . .	60
Clock . . . . .	46	Brakes . . . . .	60
Odometer and tripmeters . . . . .	47	Mirrors . . . . .	61
On-board computer <sup>OE</sup> . . . . .	50	Handlebars . . . . .	62
Tyre pressure monitoring RDC <sup>OE</sup> . . . . .	53	Spring preload . . . . .	62
Lights . . . . .	54	Damping . . . . .	63
Turn indicators . . . . .	55	Electronic Suspension Adjustment ESA <sup>OE</sup> . . . . .	64
Hazard warning flashers . . . . .	56	Tyres . . . . .	66
Emergency off switch (kill switch) . . . . .	57	Headlight . . . . .	67
Grip heating <sup>OE</sup> . . . . .	57	Front and rear seats . . . . .	68
Automatic Stability Control ASC <sup>OE</sup> . . . . .	58	Helmet holder . . . . .	70
Seat height . . . . .	59		

## Ignition switch and steering lock

### Keys

You receive one master key and one spare key. Please consult the information on the electronic immobiliser (EWS) if a key is lost or mislaid (➡ 45).

Ignition switch and steering lock, tank filler cap lock and seat lock are all operated with the same key.

with OA Case and with OA Topcase:

If you wish you can arrange to have the cases and the top-case fitted with locks that can be opened with this key as well. Consult a specialist workshop, preferably an authorised BMW Motorrad dealer.◀

## Switching on ignition

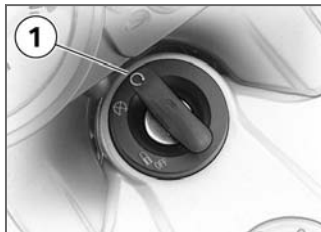

- Turn the key to position **1**.
- » Side light and all function circuits switched on.
- » Engine can be started.
- » Pre-ride check is performed. (➡ 75)

with OE BMW Motorrad Integral ABS:

- Turn the key to position **1**.
- » ABS self-diagnosis is performed in addition to the checks outlined above. (➡ 75)◀

with OE Automatic Stability Control:

- Turn the key to position **1**.
- » ASC self-diagnosis is performed in addition to the checks outlined above. (➡ 76)◀

## Switching off ignition

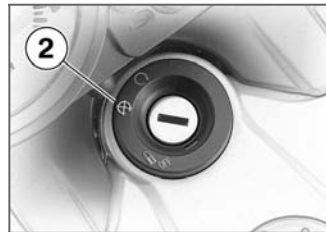

- Turn the key to position **2**.
- » Lights switched off.
- » Handlebars not locked.
- » Key can be removed.
- » Electrically powered accessories remain operational for a limited period of time.

- » The battery can be recharged via the on-board socket.

## Locking handlebars

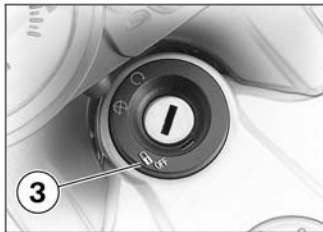

 If the motorcycle is on the side stand, the surface of the ground will determine whether it is better to turn the handlebars to the left or right. However, the motorcycle is more stable on a level surface with the handlebars turned to the left than with the handlebars turned to the right.

On level ground, always turn the handlebars to the left to set the steering lock. ◀

- Turn the handlebars to the full left or right lock position.
- Turn the key to position **3**, while moving the handlebars slightly.
  - » Ignition, lights and all function circuits switched off.
  - » Handlebars locked.
  - » Key can be removed.

## Electronic immobiliser (EWS)

### Protection against theft

The electronic immobiliser helps protect your BMW motorcycle from theft, and this enhanced security is at your disposal without any need for you to set parameters or activate additional systems. The engine of a motorcycle fitted with this electronic immobiliser can be started only with the keys that belong to the vehicle. You can also have your authorised BMW Motorrad dealer bar

individual keys, for example if a particular key goes missing. The engine cannot be started with a key that has been barred.

### In-key electronics

The motorcycle's electronics exchange certain continuously changing signals with the electronics in the key; these signals are specific to your motorcycle and they are transmitted via the ring aerial in the ignition lock. The ignition is not enabled for starting until the key has been recognised as "authorised" for your motorcycle.

 A spare key attached to the same ring as the ignition key used to start the engine could "irritate" the electronics, in which case the enabling signal for starting is not issued. The EWS warning appears in the multifunction display.

Always keep the spare key separately from the ignition key. ◀

## Replacement and extra keys

You can obtain replacement/extra keys only through an authorised BMW Motorrad dealer. The keys are part of an integrated security system, so the dealer is under an obligation to check the legitimacy of all applications for replacement/extra keys. If you want to have a lost key barred, you have to bring with you all the other keys that belong to the motorcycle. A key that has been barred can subsequently be cleared and reactivated for use.

## Clock

### Setting clock



Attempting to set the clock while riding the motorcycle can lead to accidents.

Set the clock only when the motorcycle is stationary. ◀

- Switch on the ignition.

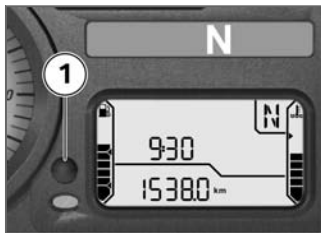

- Repeatedly press button **1** until the odometer reading appears on the display.



- Alternatively, repeatedly press button **2** until the total distance covered reading appears on the display.

with OE On-board computer or  
with OE Tyre-pressure control  
(RDC):



- Repeatedly press button **2** until the clock appears on the display.

▶ In this case, the button in the instrument cluster operates only the tripmeters. ◀◀

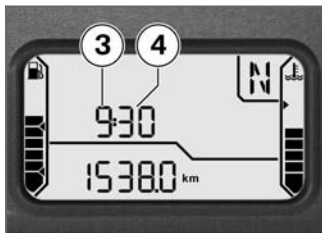

- Hold down the button.
  - » Hours reading **3** flashes.
- Press the button.
  - » The hours reading increments by one each time you press the button.
- Hold down the button.
  - » Minutes reading **4** flashes.
- Press the button.
  - » The minutes reading increments by one each time you press the button.
- Hold down the button.
  - » The clock is now set and the time appears on the display.

## Odometer and tripmeters

### Selecting readings

- Switch on the ignition.

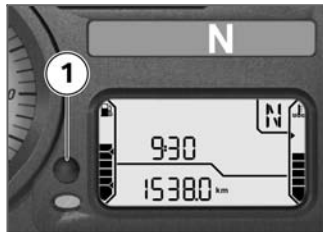

- Press button **1**.



- Alternatively, press button **2**.



The display starts with the current value and each time the button is pressed it moves one step through the following sequence:

- Total distance covered

- Tripmeter 1 (Trip I)
- Tripmeter 2 (Trip II)
- Residual range (once fuel level is down to reserve)

with OE On-board computer or with OE Tyre-pressure control (RDC):

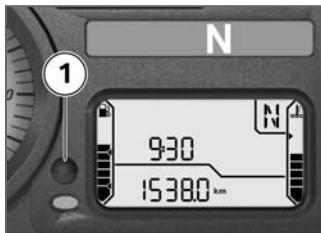

- Press button **1**.

 In this case, the button on the handlebar fitting is for operating the on-board computer or calling up the RDC readings. ◀◀

## Resetting tripmeter

- Switch on the ignition.
- Select the desired tripmeter.



- Press and hold down button **1**.



- If you prefer, you can use button **2** for this purpose.  
» The tripmeter is reset to zero.

with OE On-board computer or with OE Tyre-pressure control (RDC):

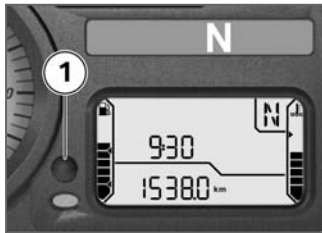

- Press button **1**.

▶ In this case, the button on the handlebar fitting is for operating the on-board computer or calling up the RDC readings.◀◀

## Residual range



Residual-range reading appears accompanied by the word **RANGE** and indicates how far you can ride with the fuel remaining in the tank. This reading is not displayed until fuel level has dropped to reserve. This distance is calculated on the basis of fuel level and average consumption.

When you refuel, the increase in fuel level is not registered unless several litres are added to the fuel already in the tank.

When refuelling after running on reserve, make sure that you top

up the tank to a level above reserve, as otherwise the sensor will not be able to register the new level. If the sensor cannot register the new level neither the fuel-level reading nor the residual-range readout can be updated.

▶ The calculated range is an approximate value. Consequently, BMW Motorrad recommends that you should not try to use the full residual range before refuelling. ◀

## On-board computer<sup>OE</sup>

### Selecting readings

- Switch on the ignition.



- Press button **1**.

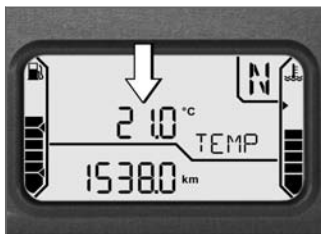

The display starts with the current value and each time the button is pressed it moves one step through the following sequence:

- Ambient temperature

- Average speed
- Average consumption
- Range
- Oil level
- Tyre pressures

## Ambient temperature



When the motorcycle is at a standstill the heat of the engine can falsify ambient-temperature reading **1**. If the effect of the engine's heat becomes excessive, – – temporarily appears on the display.



If ambient temperature drops below 3 °C a warning appears, drawing your attention to the risk of black ice forming. The display automatically switches from any other mode to the temperature reading when the temperature drops below this threshold for the first time.

## Average speed



Average speed **1** is calculated on the basis of the time elapsed since the last reset. Times during which the engine was stopped are excluded from the calculation.

## Resetting average speed

- Switch on the ignition.
- Select average speed.



- Press and hold down button **1**.  
» Average speed is reset to zero.

## Average consumption



Average consumption **1** is calculated by dividing the distance covered since the last reset by the corresponding amount of fuel used.

## Resetting average consumption

- Switch on the ignition.
- Select average consumption.



- Press and hold down button **1**.  
» Average consumption is reset to zero.

## Range



The description of the residual-range function (► 49) also covers the range readout. You can also view range **1** before the fuel level drops to reserve. A special average-consumption figure is used to calculate range; this figure is not necessarily the same as the value you can call up for viewing on the display.

When the motorcycle is propped on its side stand the slight angle of inclination means that the sensor cannot register the fuel level correctly. This is the reason why the range is calculated only

when the motorcycle is on the move.

When refuelling after running on reserve, make sure that you top up the tank to a level above reserve, as otherwise the sensor will not be able to register the new level. If the sensor cannot register the new level neither the fuel-level reading nor the range readout can be updated.

▶ The calculated range is only an approximate reading. Consequently, BMW Motorrad recommends that you should not try to use the full range before refuelling.◀

## Oil level



Oil-level indicator **1** gives you an indication of the engine oil level. You can call up this reading only when the motorcycle is at a standstill.

The preconditions for the oil level check are as follows:

- Engine at operating temperature.
- Engine idling for at least 10 seconds.
- Side stand retracted.
- Make sure the motorcycle is upright.

The readings mean:

OK: Oil level is correct.

CHECK: Check the oil level the next time you stop for fuel.

---: Oil level cannot be measured (conditions as stated above not satisfied).



If you call up another reading on the on-board computer, this symbol remains visible until the sensor again registers a correct oil level.

The most recently measured level is displayed for 5 seconds when you next switch on the ignition.

 The oil sensor might be defective if the "Check oil level" message reappears even though the oil level in the oil sight glass is correct. In this case, consult your authorised BMW Motorrad dealer. ◀

## Tyre pressure monitoring RDC<sup>OE</sup>

### Viewing tyre-pressure readings

- Switch on the ignition.



- Repeatedly press button **1** until the tyre pressures appear on the display.



The tyre pressures are shown, accompanied by the wording RDC P. The front tyre pressure is on the left; the reading on the right is the rear tyre pressure. -- -- appears directly after the ignition is switched on, because the sensors do not transmit tyre pressures until the motorcycle accelerates to 30 km/h.

The readings alternate with the clock.

If the motorcycle has an on-board computer the readings alternate with the clock and the values of the on-board computer.

## Lights

### Side light

The side lights switch on automatically when the ignition is switched on.

▶ The side lights place a strain on the battery. Do not switch the ignition on for longer than absolutely necessary. ◀

### Low-beam headlight

The low-beam headlight switches on automatically when you start the engine.

▶ When the engine is not running you can switch on the lights by switching on the ignition and either switching on the high-beam headlight or operating the headlight flasher. ◀

## High-beam headlight



- Press the top section of full-beam headlight switch **1**.
- » High-beam headlight switched on.
- Move full-beam headlight switch **1** to the centre position.
- » High-beam headlight switched off.
- Press the bottom section of full-beam headlight switch **1**.
- » The high-beam headlight is switched on until you release the button (headlight flasher).

## Switching on parking lights

- Switch off the ignition.



- Immediately after switching off the ignition, press and hold down button **1** for the left turn indicators.
- » Parking light switches on.

## Switching off parking lights

- Switch the ignition on and then off again.
- » Parking lights switched off.

## Turn indicators Switching on left flashing turn indicators

- Switch on the ignition.

▶ The turn indicators are cancelled automatically after you have ridden for approximately 10 seconds, or covered a distance of about 200 m.◀



- Press button **1** for the left-hand turn indicators.
- » Left-hand turn indicators switched on.
- » Telltale light for left-hand turn indicators flashes.

## Switching on right flashing turn indicators

- Switch on the ignition.

▶ The turn indicators are cancelled automatically after you have ridden for approximately 10 seconds, or covered a distance of about 200 m.◀

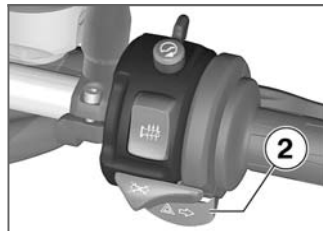

- Press button **2** for the right-hand turn indicators.
- » Right-hand turn indicators switched on.
- » Telltale light for right-hand turn indicators flashes.

## labelling C Cancelling turn indicators

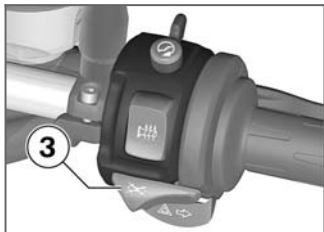

- Press cancel button **3**.
- » Flashing turn indicators switched off.
- » Turn indicator telltale lights are off.

## labelling Hazard warning flashers

### Switching on hazard warning flashers

- Switch on the ignition.

▶ The hazard warning flashers place a strain on the battery. Do not use the hazard

warning flashers for longer than absolutely necessary. ◀

▶ If you press a turn-indicator button with the ignition switched on, the turn-indicator function is activated instead of the hazard warning flashers, and remains active until you release the button. The hazard warning flashers recommence flashing as soon as the button is released. ◀

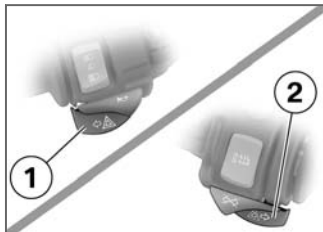

- Simultaneously press button **1** for left turn indicators and button **2** for right turn indicators.

- » The hazard warning flashers are switched on.
- » Left and right turn indicator telltale lights flash.
- Switch off the ignition.
- » The hazard warning flashers continue to operate.
- » Left and right turn indicator telltale lights are off.

### Switching off hazard warning flashers

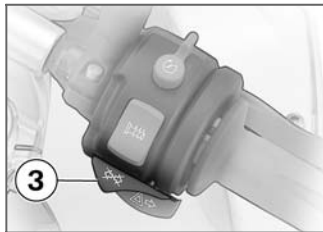

- Press cancel button **3**.
- » Hazard warning flashers switched off.

## Emergency off switch (kill switch)

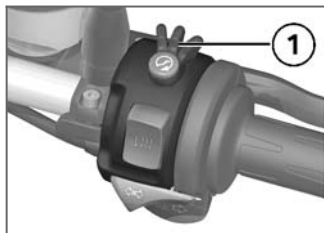

- 1 Emergency off switch (kill switch)

 Operating the kill switch when riding can cause the rear wheel to lock and thus cause a fall.

Do not operate the kill switch when riding.◀

The emergency off switch is a kill switch for switching off the engine quickly and easily.

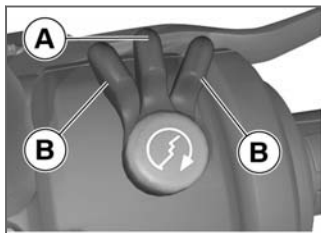

- A Normal operating position (run)  
B Engine switched off.

 You cannot start the engine unless the kill switch is in the run position.◀

## Grip heating<sup>OE</sup>

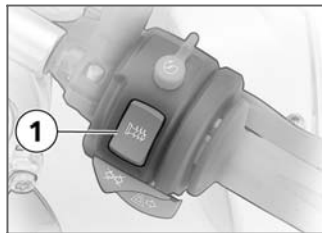

- 1 Grip-heating switch

The handlebar grips have two-stage heating. Grip heating can be activated only when the engine is running.

 The increase in power consumption caused by the grip heating can drain the battery if you are riding at low engine speeds. If the charge level is low, grip heating is switched off to ensure the battery's starting capability.◀

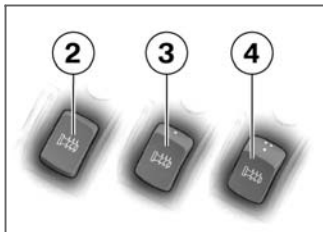

- 2 Heating off.
- 3 50 % heat output (one dot visible)
- 4 100 % heat output (three dots visible)

## Automatic Stability Control ASC<sup>OE</sup>

### Deactivating ASC function

- Switch on the ignition.

 You have the option of deactivating the ASC function while the motorcycle is on the move. ◀



- Press and hold down ASC button **1**.

 ASC symbol shows; if self-diagnosis has not completed the ASC symbol stops flashing.

- When the ASC symbol appears, release the ASC button within five seconds.

 ASC symbol continues to show.

- » The ASC function is deactivated.

### Activating ASC function



- Press and hold down ASC button **1**.

 ASC symbol no longer shows; if self-diagnosis has not completed the ASC symbol starts flashing.

- When the ASC symbol disappears, release the ASC button within five seconds.

 ASC symbol does not show; if self-diagnosis has not completed the ASC symbol continues to flash.

- » The ASC function is activated.

- Instead of pressing the ASC button, you have the option of switching the ignition off and then on again.

▶ An ASC fault has occurred if the ASC warning light shows when the motorcycle accelerates to a speed in excess of 10 km/h after the ignition was switched off and then on again.◀

## Seat height

### Adjusting seat height

- Remove the front seat (➡ 68)



- To adjust, remove seat supporting rod **1** and reinsert it at the desired height.

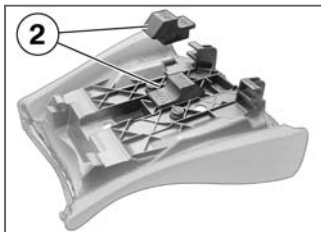

- Remove rubber wedge **2** from its holder in the underside of

the front seat and reinsert it in the desired position.

- Install the front seat (➡ 69)

## Windscreen

### Adjusting windscreen

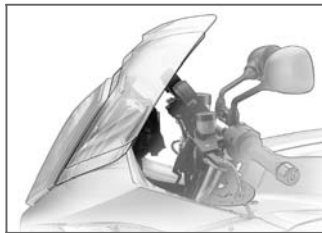



- ⚠ Attempting to adjust the windscreen while riding the motorcycle can lead to a fall. For safety reasons, do not attempt to operate the windscreen's adjusting mechanism while the motorcycle is on the move. Bring the motorcycle to a stop if you want to adjust the windscreen.◀

- Manually raise or lower the windscreen.
- » The windscreen can be set to any of three positions, engaging with an audible click at each position.

## Clutch

### Adjusting clutch lever

 If the position of the clutch fluid reservoir is changed, air can enter the clutch system. Do not twist the handlebar fitting or the handlebars. ◀

 Attempting to adjust the clutch lever while riding the motorcycle can lead to accidents. Do not attempt to adjust the clutch lever unless the motorcycle is at a standstill. ◀

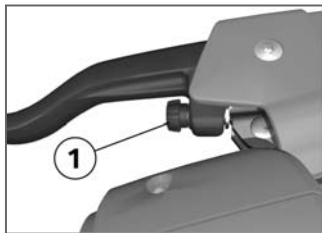

- Turn adjusting screw **1** clockwise.

 The adjusting screw is indexed and is easier to turn if you push the clutch lever forward. ◀

- » Span between handlebar grip and clutch lever increases.
- Turn adjusting screw **1** counter-clockwise.
- » Span between handlebar grip and clutch lever decreases.

## Brakes

### Adjusting handbrake lever

 Changing the position of the brake-fluid reservoir can allow air to penetrate the brake system.

Do not twist the handlebar fitting or the handlebars. ◀

 Attempting to adjust the brake lever while riding the motorcycle can lead to accidents. Do not attempt to adjust the brake lever unless the motorcycle is at a standstill. ◀

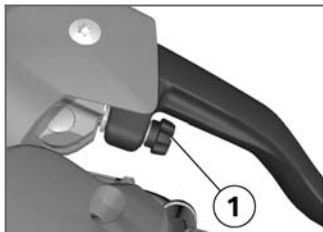

- Turn adjusting screw **1** clockwise.

▶ The adjusting screw is indexed and is easier to turn if you push the handbrake lever forward.◀

- » Span between handlebar grip and handbrake lever increases.
- Turn adjusting screw **1** counter-clockwise.
- » Span between handlebar grip and handlebar lever decreases.

## Mirrors

### Adjusting mirrors

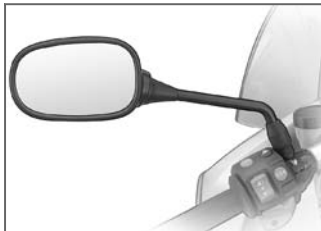

- Turn the mirror to the correct position.

## Adjusting mirror arm

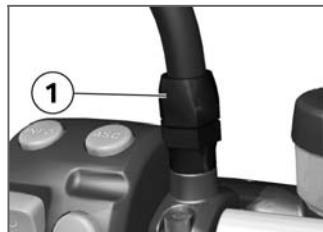

- Push the protective cap up over the threaded fastener on the mirror arm.
- Slacken nut **1**.
- Turn the mirror arm to the appropriate position.
- Tighten the nut to the specified tightening torque, while holding the mirror arm to ensure that it does not move out of position.



Mirror to clamping piece

– 25 Nm

- Push the protective cap over the threaded fastener.

## Handlebars

### Adjustable handlebars

The handlebars are height-adjustable and can be set to either of two positions. If you want to have the handlebars adjusted consult a specialist workshop, preferably an authorised BMW Motorrad dealer.

## Spring preload

### Spring preload

It is essential to set spring preload of the rear suspension to suit the load carried by the motorcycle. Increase spring preload when the motorcycle is heavily loaded and reduce spring preload accordingly when the motorcycle is lightly loaded.

### Adjusting spring preload for rear wheel

- Make sure the ground is level and firm and place the motorcycle on its stand.



**!** Your motorcycle's handling will suffer if you do not match the spring-preload and damping-characteristic settings. Adjust the damping characteristic to suit spring preload.◀

**!** Adjusting spring preload while the motorcycle is being ridden can lead to accidents. Do not attempt to adjust spring

preload unless the motorcycle is at a standstill.◀

- If you want to increase spring preload, turn knob **1** in the direction indicated by the HIGH arrow.
- If you want to reduce spring preload, turn knob **1** in the direction indicated by the LOW arrow.

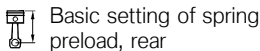

Basic setting of spring preload, rear

– Knob at "STD" mark at side (Rider weighing 85 kg, motorcycle fully fuelled)

## Adjusting damping for rear wheel

- Make sure the ground is level and firm and place the motorcycle on its stand.

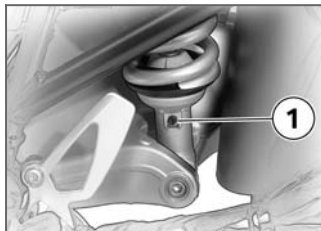

**!** There is a risk of injury by burns if you adjust the damping characteristic while the silencer is hot.

Use a screwdriver extension and wear protective gloves. ◀

- Adjust the damping characteristic, using the tool from the on-board toolkit to turn adjusting screw **1**.



- If you want a harder damping characteristic, use a screwdriver to turn adjusting screw **1** in the direction indicated by the H arrow.
- If you want a softer damping characteristic, use a screwdriver to turn adjusting screw **1** in the direction indicated by the S arrow.

## Damping Setting

Damping must be adapted to suit spring preload and the surface on which the motorcycle is ridden. An increase in spring preload requires firmer damping, a reduction in spring preload requires softer damping.

 Basic setting of rear-suspension damping characteristic

- Turn the adjusting screw as far as it will go in the direction indicated by the H arrow and then turn it back one and a half turns in the direction indicated by the S arrow. (Full load of fuel, with rider 85 kg)

## Electronic Suspension Adjustment ESA<sup>OE</sup>

### Settings

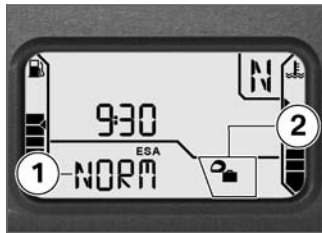

Electronic Suspension Adjustment ESA provides a convenient way of adapting the motorcycle to different conditions.

Three spring preload settings can be combined with three damping characteristics to fine-tune the motorcycle's suspension to the load it carries and the surface over which you want to ride. The damping characteristic is shown in panel **1** of the multi-function display, and spring pre-

load in panel **2**. The odometer readings are not shown while the ESA readout is active.

### Adjuster, spring preload

The ESA control unit is protected by an overload cutout designed to stop the spring-preload adjustment process if current consumption reaches an unacceptably high level. Please note that a combination of low ambient temperature and a high payload tends to increase the possibility of elevated current consumption, and under these circumstances adjustment might be interrupted by the overload cutout.

If the motorcycle is to be used for two-up riding and ambient temperature is below 0 °C, BMW Motorrad recommends adjusting the suspension to the setting for two-up riding and allowing adjustment to complete before your passenger mounts the motor-

cycle. Similarly, BMW Motorrad recommends relieving the weight on the motorcycle when you are going to adjust over a long range of travel (adjusting from "one-up" to "two-up with luggage").

The ESA indicator continues to flash until adjustment completes. If adjustment is interrupted the process resumes as soon as current consumption drops below the defined threshold, for example when the above-mentioned measures are adopted.

### Calling up settings

- Switch on the ignition.



- Press button **1**.
  - » The current setting is displayed.
  - » The reading remains visible for a few seconds before disappearing automatically.

### Adjusting suspension damping

- Switch on the ignition.

 You can adjust the damping characteristic while the motorcycle is on the move.◀



- Press button **1**.
  - » The current setting is displayed.
- Press button **1** once at each step.

The display field starts at the current status and cycles through the following sequence:

  - COMF Comfortable damping characteristic
  - NORM Normal damping characteristic
  - SPORT Sporty damping characteristic
  - » The setting shown on the display is automatically accepted

as the damping characteristic if you allow a certain length of time to pass without pressing button **1**.

## Adjusting spring preload



- Start the engine.

 You cannot adjust spring preload while the motorcycle is on the move.◀



- Press button **1**.
- » The current setting is displayed.
- Press and hold down button **1** until the reading changes.

The display field starts at the current status and cycles through the following sequence:

-  One-up
-  One-up with luggage
-  Two-up (with luggage)

» The setting shown on the display is automatically accepted as the spring preload if you allow a certain length of time to pass without pressing button **1**. The reading flashes while adjustment is in progress.

## Tyres

### Checking tyre pressures

- Make sure the ground is level and firm and place the motorcycle on its stand.

 Incorrect tyre pressures impair the motorcycle's handling characteristics and increase the rate of tyre wear. Always check that the tyre pressures are correct.◀

 At high road speeds, tyre valves have a tendency to open as a result of centrifugal force.

Fit metal valve caps with rubber seals and screw them on firmly to prevent sudden deflation.◀

- Check tyre pressures against the data below.

	Tyre pressure, front
– 2.2 bar (one-up, tyre cold)	
– 2.5 bar (two-up and/or with luggage, tyre cold)	



Tyre pressure, rear

– 2.5 bar (one-up, tyre cold)

– 2.9 bar (two-up and/or with luggage, tyre cold)

If tyre pressure is too low:

- Correct tyre pressure.

## Headlight

### Adjusting headlight for driving on left/driving on right

If the motorcycle is ridden in a country where the opposite rule of the road applies, its asymmetric low-beam headlight will tend to dazzle oncoming traffic.

Have the headlight set accordingly by a specialist workshop, preferably an authorised BMW Motorrad dealer.



Commercially available adhesive tape will damage the plastic lens of the light.

Consult a specialist workshop, preferably an authorised BMW Motorrad dealer, in order to avoid damaging the plastic lens of the light. ◀

### Headlight beam throw and spring preload

Headlight beam throw is generally kept constant when spring preload is adjusted to suit load. Spring preload adjustment might not suffice only if the motorcycle is very heavily loaded. Under these circumstances, headlight beam throw has to be adjusted to suit the weight carried by the motorcycle.



Consult a specialist workshop, preferably an authorised BMW Motorrad dealer, if you are unsure whether

the headlight basic setting is correct. ◀

### Headlight beam-throw adjustment



- 1 Headlight beam-throw adjustment

Spring preload adjustment might not suffice if the motorcycle is very heavily loaded. Moving the pivot lever adjusts headlight beam throw so as not to dazzle oncoming traffic.

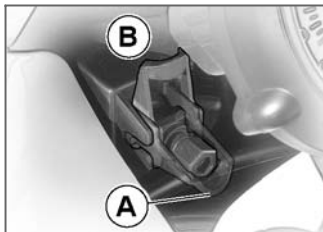

- A** Neutral position  
**B** Position for heavy load

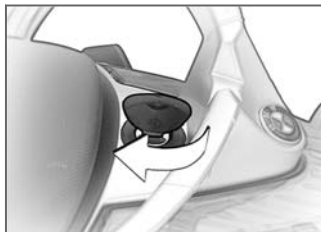

- Turn the key clockwise in the seat lock.



- Pull the seat to the rear to release it from its holders.

## Front and rear seats

### Removing rear seat

- Make sure the ground is level and firm and place the motorcycle on its stand.

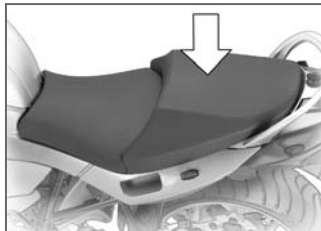

- At the same time, press down on the rear seat.
- Lift the rear seat and release the key.

### Removing front seat

- Remove the rear seat (🔧 68)



- Pull the front seat slightly to the rear and lift it up to remove.

### Installing front seat

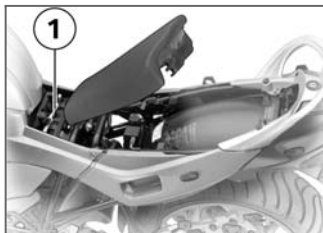

 If too much pressure is applied in the forward direction, there is a danger that the

motorcycle will be pushed off its stand.

Always make sure that the motorcycle is stable and firmly supported. ◀

- Push the front seat forward into holder 1.
- Position the rear of the front seat on the mounts.



- Make sure that the seat is correctly located.
- Install the rear seat (➡ 69)

### Installing rear seat

- Install the front seat (➡ 69)

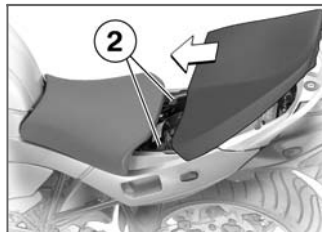

- Position the rear seat in such a way that the tongues engage underneath the corresponding holders 2.

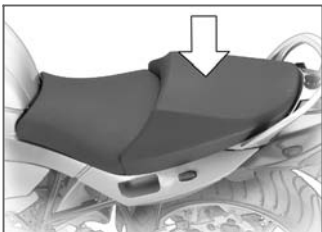

**!** If too much pressure is applied in the forward direction, there is a danger that the motorcycle will be pushed off its stand.

Always make sure that the motorcycle is stable and firmly supported. ◀

- Firmly press down on the rear seat at the rear.
- » The rear seat engages with an audible click.

## Helmet holder

### Securing helmet to motorcycle

- Remove the rear seat (➡ 68)



- Use the wire rope available as an optional accessory to secure the helmet to helmet holders **1**.

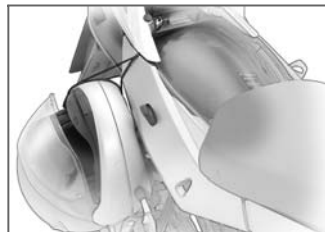

**!** The helmet catch can scratch the panelling. Make sure the lock is out of the way when you hook the helmet into position. ◀

- Pass the steel cable through the helmet and push it onto one of the helmet holders.
- Install the rear seat (➡ 69)

## **Riding**

Safety instructions .....	72
Checklist .....	73
Starting .....	74
Running in .....	77
Brakes .....	77
Parking your motorcycle .....	79
Refuelling .....	80

## Safety instructions

### Rider's equipment

Do not ride without the correct clothing. Always wear:

- Helmet
- Motorcycling jacket and trousers
- Gloves
- Boots

This applies even to short journeys, and to every season of the year. Your authorised BMW Motorrad dealer will be glad to advise you on the correct clothing for every purpose.

### Speed

If you ride at high speed, always bear in mind that various boundary conditions can adversely affect the handling of your motorcycle:

- Settings of the spring-strut and shock-absorber system
- Imbalanced load
- Loose clothing
- Insufficient tyre pressure
- Poor tyre tread
- Etc.

### Correct loading



Overloading and imbalanced loads can adversely affect the motorcycle's handling. Do not exceed the permissible gross weight and be sure to comply with the instructions on loading. ◀

### Alcohol and drugs



Even small amounts of alcohol or drugs will adversely affect your perception and your ability to assess situations and make decisions, and slow down your reflexes. Medication can exacerbate these effects.

Do not ride your motorcycle after consuming alcohol, drugs and/or medication. ◀

### Risk of poisoning

Exhaust fumes contain carbon monoxide, which is colourless and odourless but highly toxic.



Inhaling the exhaust fumes therefore represents a health hazard and can even cause loss of consciousness with fatal consequences.

Do not inhale exhaust fumes. Do not run the engine in an enclosed space. ◀

### High voltage



Touching live parts of the ignition system with the engine running can cause electric shock.

Do not touch parts of the ignition system when the engine is running. ◀

## Catalytic converter

If misfiring causes unburned fuel to enter the catalytic converter, there is a danger of overheating and damage.

For this reason, observe the following points:

- Do not run the fuel tank dry.
- Do not attempt to start or run the engine with a spark-plug cap disconnected.
- Stop the engine immediately if it misfires.
- Use only unleaded fuel.
- Comply with all specified maintenance intervals.

 Unburned fuel will destroy the catalytic converter. Note the points listed for protection of the catalytic converter. ◀

## Risk of fire

Temperatures at the exhaust are high.

 Flammable materials (e.g. hay, leaves, grass, clothing and luggage, etc.) could ignite if allowed to come into contact with the hot exhaust pipe.

Do not permit flammable materials to come into contact with the hot exhaust system. ◀

 Cooling would be inadequate if the engine were allowed to idle for a lengthy period with the motorcycle at a standstill: overheating would result. In extreme cases, the motorcycle could catch fire.

Do not allow the engine to idle unnecessarily. Ride away immediately after starting the engine. ◀

## Tampering with the engine control unit

 Tampering with the engine control unit can damage the motorcycle and cause accidents.

Do not tamper with the engine control unit. ◀

 Tampering with the engine control unit can result in mechanical loads that the motorcycle's components are not designed to withstand. Damage caused in this way is not covered by the warranty.

Do not tamper with the engine control unit. ◀

## Checklist

Use the following checklist to check important functions, settings and wear limits before you ride off.

- Brakes
- Brake-fluid levels, front and rear
- Clutch
- Clutch fluid level
- Shock absorber setting and spring preload
- Tyre-tread depth and tyre pressures
- Cases correctly installed and luggage secured

At regular intervals:

- Engine oil level (every refuelling stop)
- Brake-pad wear (every third refuelling stop)

## Starting

### Side stand

You cannot start the motorcycle with the side stand extended and a gear engaged. The engine will switch itself off if you start it with the gearbox in neutral and then

engage a gear before retracting the side stand.

### Gearbox

You can start the engine when the gearbox is in neutral or if you pull the clutch with a gear engaged. Do not pull the clutch until after you have switched on the ignition, as otherwise the engine will refuse to start.

### Starting engine.

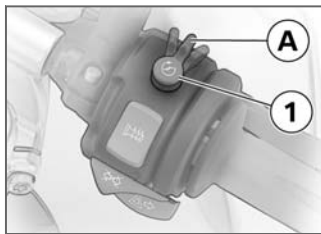

- Kill switch **1** in run position **A**.
- Switch on the ignition.

- » Pre-ride check is performed. (☛ 75)

with OE BMW Motorrad Integral ABS:

- Switch on the ignition.
- » Pre-ride check is performed. (☛ 75)
- » ABS self-diagnosis is performed. (☛ 75)◁

with OE Automatic Stability Control:

- Switch on the ignition.
- » Pre-ride check is performed. (☛ 75)
- » ABS self-diagnosis is performed. (☛ 75)
- » ASC self-diagnosis is performed. (☛ 76)◁

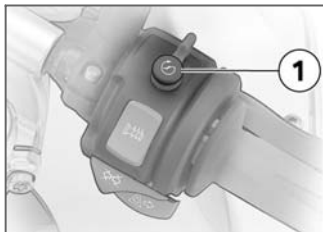

- Press starter button **1**.

▶ If ambient temperatures are very low, you might find it necessary to open the throttle slightly when starting the engine. At ambient temperatures below 0 °C, disengage the clutch after switching on the ignition. ◀

▶ The start attempt is automatically interrupted if battery voltage is too low. Recharge the battery before you start the engine, or use jump leads and a donor battery to start. ◀

» The engine starts.

» Consult the troubleshooting chart below if the engine refuses to start. (▶▶ 136)

## Pre-ride check

The instrument cluster runs a test of the 'General' warning light when the ignition is switched on: this is the "Pre-Ride-Check". The 'General' warning light shows first red and then yellow, so that you can check that it is in working order. The test is aborted if you start the engine before it completes.

### Phase 1

 General warning light shows red.

– CHECK ! appears on the display.

### Phase 2

 General warning light shows yellow.

– CHECK ! appears on the display.

If the 'General' warning light does not show:

 Some malfunctions cannot be indicated if the 'General' warning light cannot be displayed.

Check that the 'General' warning light comes on, and that it shows red and yellow. ◀

- Have the fault rectified as quickly as possible by a specialist workshop, preferably an authorised BMW Motorrad dealer.

## ABS self-diagnosis<sup>OE</sup>

BMW Motorrad Integral ABS performs self-diagnosis to ensure its operability. Self-diagnosis is performed automatically when you switch on the ignition. The motorcycle has to move forward

at a speed above 5 km/h for the wheel sensors to be tested.

### Phase 1

» Test of the diagnosis-compatible system components with the motorcycle at a standstill.



ABS warning light flashes.



Possible national variant of the ABS warning light.

### Phase 2

» Test of the wheel sensors as the motorcycle pulls away from rest.



ABS warning light flashes.



Possible national variant of the ABS warning light.

### ABS self-diagnosis completed

» The ABS warning light goes out.

If an indicator showing an ABS fault appears when ABS self-diagnosis completes:

- You can continue to ride. Bear in mind that neither the ABS function nor the integral braking function is available.
- Have the fault rectified as quickly as possible by a specialist workshop, preferably an authorised BMW Motorrad dealer.

### ASC self-diagnosis<sup>OE</sup>

BMW Motorrad ASC performs self-diagnosis to ensure its operability. Self-diagnosis is performed automatically when you switch on the ignition. The engine must be running and the motorcycle must reach a speed of at least 5 km/h in order for ASC self-diagnosis to complete.

### Phase 1

» Test of the diagnosis-compatible system components with the motorcycle at a standstill.



ASC symbol flashes.

### Phase 2

» Test of the diagnosis-compatible system components while the motorcycle is on the move.



ASC symbol flashes.

### ASC self-diagnosis completed

» The ASC warning light goes out.

If an indicator showing an ASC fault appears when ASC self-diagnosis completes:

- You can continue to ride. Bear in mind that the ASC function is not available.
- Have the fault rectified as quickly as possible by a

specialist workshop, preferably an authorised BMW Motorrad dealer.

## Running in

### The first 1000 km

- While running in the motorcycle, vary the throttle opening and engine-speed range frequently.
- Try to do most of your riding during this initial period on twisting, fairly hilly roads, avoiding high-speed main roads and highways if possible.

 Exceeding the specified engine speeds while running in will lead to increased engine wear.

Keep to the specified engine speeds for running in. ◀

- Do not exceed the rpm limits recommended for running in.



Running-in speed

– max 4000 min<sup>-1</sup>

- No full-load acceleration.
- Avoid low engine speeds at full load.
- Do not omit the first inspection after 500 - 1200 km.

### Brake pads

New brake pads must "bed down" and therefore do not achieve their optimum friction levels during the first 500 km. You can compensate for this initial reduction in braking efficiency by exerting greater pressure on the levers.



New brake pads can extend stopping distance by a significant margin.

Apply the brakes in good time. ◀

## Tyres

New tyres have a smooth surface. This must be roughened by riding in a restrained manner at various heel angles until the tyres are run in. This running in procedure is essential if the tyres are to achieve maximum grip.



Tyres do not have their full grip when new and there is a risk of accidents at extreme angles of heel.

Avoid extreme angles of heel. ◀

## Brakes

### How can stopping distance be minimised?

Each time the brakes are applied, a load distribution shift takes place with the load shifting forward from the rear to the front wheel. The sharper the motorcycle decelerates, the more load is shifted to the front wheel. The higher the wheel load, the more

braking force can be transmitted without the wheel locking.

To optimise stopping distance, apply the front brakes rapidly and keep on increasing the force you apply to the brake lever. This makes the best possible use of the dynamic increase in load at the front wheel. Remember to pull the clutch at the same time. In the "panic braking situations" that are trained so frequently braking force is applied as rapidly as possible and with the rider's full force exerted on the brake levers; under these circumstances the dynamic shift in load distribution cannot keep pace with the increase in deceleration and the tyres cannot transmit the full braking force to the surface of the road. ABS has to intervene to keep the front wheel from locking; this increases stopping distance.

## Descending mountain passes

 There is a danger of the brakes fading if you use only the rear brakes when descending mountain passes. Under extreme conditions, the brakes could overheat and suffer severe damage.

Use both front and rear brakes, and make use of the engine's braking effect as well. ◀

## Wet brakes

 After the motorcycle has been washed, ridden through water or ridden in the rain, the brake discs and pads might be wet and the brakes might not take effect immediately.

Apply the brakes in good time until the brakes have dried out. ◀

## Salt on brakes

 The brakes may fail to take effect immediately if the motorcycle was ridden on salt-covered roads and the brakes were not applied for some time. Apply the brakes in good time until the salt layer on the brake discs and brake pads has been removed. ◀

## Oil or grease on brakes

 Oil and grease on the brake discs and pads considerably diminish braking efficiency. Especially after repair and maintenance work, make sure that the brake discs and brake pads are free of oil and grease. ◀

## Dirt or mud on brakes

 When riding on loose surfaces or muddy roads, the brakes may fail to take effect immediately because of dirt or

moisture on the discs or brake pads.

Apply the brakes in good time until the brakes have been cleaned.◀

 The brake pads will wear more rapidly if you ride frequently on unsurfaced tracks or poor roads.

Check the thickness of the brake pads more frequently and replace the brake pads in good time.◀

## Parking your motorcycle

### Placing motorcycle on side stand

 If the ground is soft or uneven, there is no guarantee that the motorcycle will rest firmly on the stand.

Always check that the ground under the stand is level and firm.◀

- Switch off the engine.
- Pull the handbrake lever.
- Hold the motorcycle upright and balanced.
- Use your left foot to extend the side stand fully.

 The side stand is designed to support only the weight of the motorcycle.

Do not lean or sit on the motorcycle with the side stand extended.◀

- Slowly lean the motorcycle to the side until its weight is taken by the stand and dismount to the left.

 If the motorcycle is on the side stand, the surface of the ground will determine whether it is better to turn the handlebars to the left or right. However, the motorcycle is more stable on a level surface with the handlebars turned to the left than with

the handlebars turned to the right.

On level ground, always turn the handlebars to the left to set the steering lock.◀

- Turn the handlebars to full left or right lock.
- Check that the motorcycle is standing firmly.

 On a gradient, the motorcycle should always face uphill; select 1st gear.◀

- Lock the steering lock.

### Removing motorcycle from side stand

- Unlock the steering lock.
- From the left, grip the handlebars with both hands.
- Pull the handbrake lever.
- Swing your right leg over the seat and lift the motorcycle to the upright position.

- Hold the motorcycle upright and balanced.

 An extended side stand can catch on the ground when the motorcycle is moving and lead to a fall.

Retract the side stand before moving the motorcycle.◀

- Sit on the motorcycle and use your left foot to retract the side stand.

## Placing motorcycle on centre stand<sup>OA</sup>

 If the ground is soft or uneven, there is no guarantee that the motorcycle will rest firmly on the stand.

Always check that the ground under the stand is level and firm.◀

- Switch off the engine.
- Dismount and keep your left hand on the left handlebar grip.

- With your right hand, grip the rear grab handle or the rear frame.
- Use your right foot on the pin of the centre stand to press the stand down until its curved feet touch the ground.
- Place your full body weight on the centre stand and at the same time pull the motorcycle to the rear.

 Excessive movements could cause the centre stand to retract, and the motorcycle would topple in consequence.

Do not lean or sit on the motorcycle with the centre stand extended.◀

- Check that the motorcycle is standing firmly.
- Lock the steering lock.

## Removing motorcycle from centre stand<sup>OA</sup>

- Unlock the steering lock.
- Place your left hand on the left handlebar grip.
- With your right hand, grip the rear grab handle or the rear frame.
- Push the motorcycle forward off the centre stand.
- Check that the centre stand has fully retracted.

## Refuelling

 Fuel is highly flammable. A naked flame close to the fuel tank can cause a fire or explosion.

Do not smoke. Never bring a naked flame near the fuel tank.◀

 Fuel expands when hot. Fuel escaping from an overfilled tank could make its way onto the rear tyre. This could cause a fall.

Do not fill the tank past the bottom edge of the filler neck. ◀

 Fuel attacks plastics, which become dull or unsightly. Wipe off plastic parts immediately if they come into contact with fuel. ◀

 Fuel can attack the material of the windscreen and the side slipstream deflectors, which become dull or unsightly. Wipe off the windscreen and slipstream deflectors immediately if they come into contact with fuel. ◀

 Leaded fuel will destroy the catalytic converter. Use only unleaded fuel. ◀

- Make sure the ground is level and firm and place the motorcycle on its stand.



- Open the protective cap.
- Open the fuel tank cap with the ignition key by turning it counter-clockwise.
- Refuel with fuel of the grade stated below; do not fill the tank past the bottom edge of the filler neck.



Recommended fuel grade

– 98 ROZ/RON (Premium plus unleaded)



Recommended fuel grade

– 95 ROZ/RON (Premium unleaded (fuel grade, usable with power- and consumption-related restrictions))



Usable fuel capacity

– 21 l



Reserve fuel

–  $\geq 4$  l

- Press the fuel tank cap down firmly to close.
- Remove the key and close the protective cap.



## Engineering details

Brake system with BMW Motorrad Integral ABS <sup>OE</sup> .....	84
Electronic engine management with BMW Motorrad ASC <sup>OE</sup> .....	86
Tyre pressure monitoring RDC <sup>OE</sup> .....	88

## Brake system with BMW Motorrad Integral ABS<sup>OE</sup>

### Partially integral brakes

Your motorcycle is equipped with partially integral brakes. Both front and rear brakes are applied when you pull the handbrake lever. The footbrake lever acts only on the rear brake.

While the brakes are slowing the motorcycle, the BMW Motorrad Integral ABS adapts braking-force distribution between front and rear brakes to suit the load on the motorcycle.



The integral braking function makes it very difficult to spin the rear wheel by opening the throttle with the front brake applied to keep the motorcycle stationary (burn-out). Attempted burn-outs can result in damage to the rear brake and the clutch. Do not attempt burn-outs. ◀

### How does ABS work?

The amount of braking force that can be transferred to the road depends on factors that include the coefficient of friction of the road surface. Loose stones, ice and snow or a wet road all have much lower coefficients of friction than a clean, dry asphalt surface. The lower the coefficient of friction, the longer the braking distance.

If the rider increases braking pressure to the extent that braking force exceeds the maximum transferrable limit, the wheels start to lock and the motorcycle loses its directional stability; a fall is imminent. Before this situation can occur, ABS intervenes and adapts braking pressure to the maximum transferrable braking force, so the wheels continue to turn and directional stability is maintained irrespective of the condition of the road surface.

### What are the effects of surface irregularities?

Humps and surface irregularities can cause the wheels to lose contact temporarily with the road surface; if this happens the braking force that can be transmitted to the road can drop to zero. If the brakes are applied under these circumstances the ABS has to reduce braking force to ensure that directional stability is maintained when the wheels regain contact with the road surface. At this instant the BMW Motorrad Integral ABS must assume an extremely low coefficient of friction, so that the wheels will continue to rotate under all imaginable circumstances, because this is the precondition for ensuring directional stability. As soon as it registers the actual circumstances, the system reacts instantly and adjusts brak-

ing force accordingly to achieve optimum braking.

## **What feedback does the rider receive from the BMW Motorrad Integral ABS?**

If the ABS system has to reduce braking force on account of the circumstances described above, vibration is perceptible through the handbrake lever.

When the handbrake lever is pulled, brake pressure is also built up at the rear wheel by the integral function. If the brake pedal is depressed after the handbrake lever is pulled, the brake pressure built up beforehand is perceptible as counter-pressure sooner than is the case when the brake pedal is depressed either before or at the same time as the brake lever is pulled.

## **Rear wheel lift**

Even under severe braking, a high level of tyre grip can mean that the front wheel does not lock up until very late, if at all. Consequently, ABS does not intervene until very late, if at all. Under these circumstances the rear wheel can lift off the ground, and the outcome can be a high-siding situation in which the motorcycle can flip over.



Severe braking can cause the rear wheel to lift off the ground.

When you brake, bear in mind that ABS control cannot be relied on in all circumstances to prevent the rear wheel from lifting clear of the ground. ◀

## **What is the design baseline for BMW Motorrad Integral ABS?**

Within the limits imposed by physics, the BMW Motorrad Integral ABS ensures directional stability on any surface. The system is not optimised for special requirements that apply under extreme competitive situations off-road or on the track.

## **Special situations**

The speeds of the front and rear wheels are compared as one means of detecting a wheel's incipient tendency to lock. If the system registers implausible values for a lengthy period the ABS function is deactivated for safety reasons and an ABS fault message is issued. Self-diagnosis has to complete before fault messages can be issued.

In addition to problems with the BMW Motorrad Integral ABS,

exceptional riding conditions can lead to a fault message being issued.

### **Exceptional riding conditions:**

- Heating up with the motorcycle on the centre stand or an auxiliary stand, engine idling or with a gear engaged.
- Rear wheel locked by the engine brake for a lengthy period, for example while descending off-road.

If a fault message is issued on account of exceptional riding conditions as outlined above, you can reactivate the ABS function by switching the ignition off and on again.

## **What significance devolves on regular maintenance?**



Invariably, a technical system cannot perform beyond the abilities dictated by its level of maintenance.

In order to ensure that the BMW Motorrad ABS is always maintained in optimum condition, it is essential for you to comply strictly with the specified inspection intervals. ◀

## **Reserves for safety**

The potentially shorter braking distances which BMW Motorrad Integral ABS permits must not be used as an excuse for careless riding. ABS is primarily a means of ensuring a safety margin in genuine emergencies.

Take care when cornering. When you apply the brakes on a corner, the motorcycle's weight and

momentum take over and even BMW Motorrad Integral ABS is unable to counteract their effects.

## **Electronic engine management with BMW Motorrad ASC<sup>OE</sup>**

### **How does ASC work?**

The BMW Motorrad ASC compares the speed of rotation of the front wheel and the rear wheel. The differential is used to compute slip as a measure of the reserves of stability available at the rear wheel. If slip exceeds a certain limit the electronic engine management system intervenes, adapting engine torque accordingly.

## What is the design baseline for BMW Motorrad ASC?

BMW Motorrad ASC is designed as an assistant system for the rider and for use on public roads. The extent to which the rider affects ASC control can be considerable (weight shifts when cornering, items of luggage loose on the motorcycle), especially when style of riding takes rider and machine close to the limits imposed by physics. The system is not optimised for special requirements that apply under extreme competitive situations off-road or on the track. You have the option of deactivating the BMW Motorrad ASC system for these circumstances.



Even ASC is constrained by the laws of physics. Invariably, the rider bears responsibility for assessing road and traffic

conditions and adopting his or her style of riding accordingly. Do not take risks that would negate the additional safety offered by this system. ◀

### Special situations

In accordance with the laws of physics, the ability to accelerate is restricted more and more as the angle of heel increases. Consequently, there can be a perceptible lag in acceleration out of very tight bends.

The speeds of the front and rear wheels are compared as one means of detecting the rear wheel's incipient tendency to spin or slip sideways. If the system registers implausible values for a lengthy period the ASC function is deactivated for safety reasons and an ASC fault message is issued. Self-diagnos-

is has to complete before fault messages can be issued. The BMW Motorrad ASC can shut down automatically under the exceptional riding conditions outlined below.

### Exceptional riding conditions:

- Riding for a lengthy period with the front wheel lifted off the ground (wheelie) and ASC deactivated.
- Rear wheel rotating with the motorcycle held stationary by applying the front brake (burn-out).
- Heating up with the motorcycle on the centre stand or an auxiliary stand, engine idling or with a gear engaged.

Accelerating the motorcycle to a speed in excess of 10 km/h after switching the ignition off and then on again reactivates the ASC.

If the front wheel lifts clear of the ground under severe acceleration, the ASC reduces engine torque until the front wheel regains contact with the ground. Under these circumstances, BMW Motorrad recommends rolling the throttle slightly closed so as to restore stability with the least possible delay.

When riding on a slippery surface, never snap the throttle twistgrip fully closed without pulling the clutch at the same time. Engine braking torque can cause the rear wheel to lock, with a corresponding loss of stability. The BMW Motorrad ASC is unable to control a situation of this nature.

## Tyre pressure monitoring RDC<sup>OE</sup>

### Function

A sensor integrated into each tyre measures the air temperature and the air pressure inside the tyre and transmits this information to the control unit. Each sensor has a centrifugal-force tripswitch that does not enable transmission of the measured values until the motorcycle has accelerated to about 30 km/h. The display shows -- for each tyre until the tyre-pressure signal is received for the first time. The sensors continue to transmit the measured-value signals for approximately 15 minutes after the motorcycle comes to a stop.

The control unit can administer four sensors, so two different sets of wheels with RDC sensors can be alternated on

the motorcycle. An error message is issued if wheels without sensors are fitted to a motorcycle equipped with an RDC control unit.

### Temperature compensation

The tyre-pressure readings shown by the multifunction display are temperature-compensated; the reference tyre temperature for these readings is always 20 °C. The air lines available to the public in petrol stations and motorway service areas almost invariably show temperature-dependent tyre pressures, so in most instances these gauge readings will not tally with the readings shown by the multifunction display.

## Tyre-pressure ranges

The RDC control unit differentiates between three tyre-pressure ranges, all of which are parameterised for the motorcycle:

- Tyre pressure within permitted tolerance.
- Tyre pressure close to limit of permitted tolerance.
- Tyre pressure outside permitted tolerance.

A warning is also issued if tyre pressure drops sharply but stays within the permitted tolerance.



## Accessories

General instructions.....	92
Power socket .....	92
Luggage .....	93
Case <sup>OA</sup> .....	94
Topcase <sup>OA</sup> .....	96

## General instructions

BMW Motorrad recommends the use of parts and accessories for your motorcycle that are approved by BMW for this purpose. Genuine BMW parts and accessories and other products which BMW has approved can be obtained from your authorised BMW Motorrad dealer, together with expert advice on their installation and use.

These parts and products have been tested by BMW for safety, function and suitability. BMW accepts product liability for them. Conversely, BMW is unable to accept any liability whatsoever for parts and accessories which it has not approved.



BMW Motorrad cannot assess each non-BMW product to determine whether it can be used on or in connection with BMW motorcycles

without constituting a safety hazard. Country-specific official authorisation does not suffice as assurance. Tests conducted by these instances cannot make provision for all operating conditions experienced by BMW motorcycles and, consequently, they are not sufficient in some circumstances.

Use only parts and accessories approved by BMW for your motorcycle. ◀

Whenever you are planning modifications, comply with all the legal requirements. Make sure that the motorcycle does not infringe national road-vehicle construction and use regulations.

## Power socket

### Ratings



The supply to the socket is cut off automatically if battery voltage is low or the load exceeds the maximum rating.

### Operating electrical accessories

You can start using electrical accessories only when the ignition is switched on. The accessory remains operational if the ignition is subsequently switched off. In order to ensure that the drain on the on-board power supply sys-

tem is minimised, the supply to the power socket is cut off approximately 15 minutes after the ignition is switched off, and it is also temporarily interrupted during the start procedure.

## Cable routing

The cables from the power socket to the auxiliary device must be routed in such a way that they:

- do not impede the rider
- do not restrict or obstruct the steering angle and handling characteristics
- cannot be trapped

 Incorrectly routed cables can impede the rider. Route the cables as described above. ◀

## Luggage

### Correct loading

 Overloading and imbalanced loads can adversely affect the motorcycle's handling. Do not exceed the permissible gross weight and be sure to comply with the instructions on loading. ◀

- Set spring preload, damping characteristic and tyre pressures to suit total weight.
- Ensure that the case volumes on the left and right are equal.
- Make sure that the weight is uniformly distributed between right and left.
- Pack heavy items at the bottom and toward the inboard side.
- Note the maximum permissible payload of the cases and the speed limit for riding with cases on the motorcycle.



Payload of cases

– ≤10 kg



Maximum permissible speed for riding with cases fitted to the motorcycle

– ≤180 km/h

- Note the maximum permissible payload of the topcase and the speed limit for riding with a topcase on the motorcycle.



Payload of topcase

– ≤5 kg



Maximum permissible speed for riding with topcase fitted to the motorcycle

– ≤180 km/h

- Note the maximum permissible payload of the tank rucksack.



Payload of tank rucksack

- ≤5 kg

- Note the maximum permissible payload of the tankbag.



Payload of tankbag

- ≤5 kg

- Note the maximum permissible payload of the luggage carrier.



Payload of luggage carrier

- ≤10 kg

with OA Topcase:

- ≤5 kg<

## Case<sup>OA</sup>

### Opening cases

- Turn the lock with the key until it is transverse to the forward direction of travel.
- » The case is unlocked.

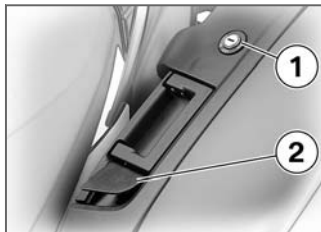

- Press lock barrel **1**.
- » Lever **2** pops up.

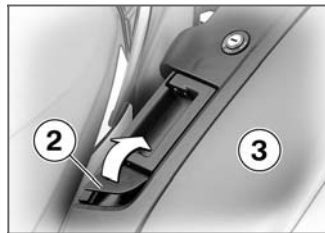

- Pivot lever **2** down.
- Open lid **3**.

### Closing cases



- Pivot lever **2** all the way down.

- Close lid **3** and press it down. Check that nothing is trapped between the lid and the case.



- Push lever **2** down.
  - » The lever engages.
- Turn the lock with the key until it is in line with the forward direction of travel.
  - » The case is closed.

### Removing cases

- Turn the lock with the key until it is transverse to the forward direction of travel.

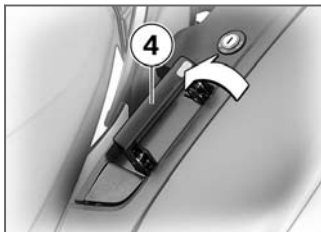

- Turn the key clockwise (left case) or counter-clockwise (right case).
  - » Handle **4** pops out.



- Pull the handle out and then pull it up as far as it will go.

- » The case is released and can be removed.

### Installing cases

- Unlatch the handle and pull it up as far as it will go.

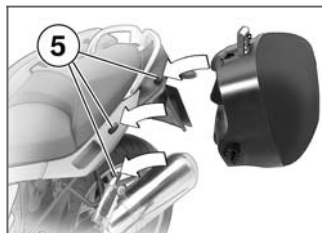

- Seat the case in holders **5**.



- Push the case handle down until it engages.
- » The case is correctly engaged on its holders.
- Turn the lock with the key until it is in line with the forward direction of travel.
- » The case is closed.
- Check that the case is secure.

## Topcase<sup>OA</sup>

### Opening topcase



- Turn the lock barrel in the topcase to the vertical position.
- » The topcase is open.
- Press lock barrel **7**.
- » Locking lever **8** pops out.
- Fully open locking lever **8**.



- Open lid **9**.

### Closing topcase



- Fully open locking lever **8**.
- Snap the lid of the compartment closed and push it down.

Check that nothing is trapped between the lid and the case.

- Push locking lever **8** down until it engages.



- Turn the lock barrel to the horizontal position.  
» The topcase is closed.

### Removing topcase

- Turn the lock barrel to the horizontal position.  
» The topcase is locked.

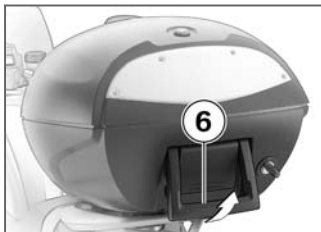

- Turn the key clockwise.  
» Handle **6** pops out.
- Pull handle **6** up as far as it will go.



- Lift the topcase at the rear and pull it off the carrier.

### Installing topcase



- Pull handle **6** up as far as it will go.

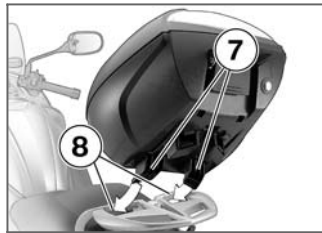

- Hook the topcase into position on the carrier. Make sure that

hooks **7** are securely seated in the corresponding keepers **8**.



- Push the handle down until it engages.
- » The topcase is correctly engaged on its carrier.

## Maintenance

General instructions.....	100
Toolkit .....	100
Engine oil .....	101
Brake system, general .....	103
Brake pads .....	103
Brake fluid .....	105
Clutch .....	107
Tyres .....	108
Rims.....	109
Wheels .....	109
Front-wheel stand .....	116
Rear-wheel stand .....	118
Bulbs .....	118
Jump starting .....	126
Battery.....	127

## General instructions

The Maintenance chapter describes straightforward procedures for checking and replacing certain wear parts.

Special tightening torques are listed as applicable. The tightening torques for the threaded fasteners on your motorcycle are listed in the section entitled "Technical data".

You will find information on more extensive maintenance and repair work in the Repair Manual on DVD/CD-ROM (RepROM) for your motorcycle, which is available from your authorised BMW Motorrad dealer.

Some of the work calls for special tools and a thorough knowledge of motorcycles. If you are in doubt consult a specialist workshop, preferably your authorised BMW Motorrad dealer.

## Toolkit

### Standard on-board toolkit

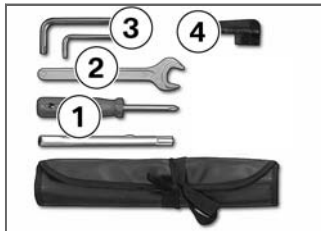

#### 1 Screwdriver with reversible blade

- Removing and installing turn indicator glass
- Adjusting rebound stage

#### 2 Open-ended spanner, w/f 17

- Adjust the mirror arm

#### 3 TORX bits T25, T45

- Removing and installing rear light glass

#### 4 Tool for oil cap

- Removing and installing plug for oil filler neck

### On-board toolkit service kit

Your authorised BMW Motorrad dealer can provide the on-board toolkit service kit that you will need if you are considering undertaking more extensive work. You will find information on undertaking work of this nature in the Repair Manual on the DVD/CD-ROM also obtainable from your authorised BMW Motorrad dealer.

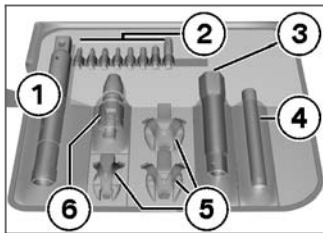

### 1 Extending tool holder

- Adapters to accommodate all tools
- Removing and installing spark plugs

### 2 1/4" bits

- 5x Torx, for example for removing and installing rear wheel
- 2x cross-head bits
- 1x plain screwdriver bit

### 3 3/8" adapter for socket-head screws, w/f 22

- Removing and installing front axle

### 4 Electric torch

- LED bulb

### 5 Socket

- 3x open-ended spanner, for example for connecting and disconnecting leads to battery terminals

### 6 Adapter

- Adapter for 1/4" bits
- 9x12 mm and 3/8" swivel adapters

## Engine oil

### Checking engine oil level

 The engine can seize if the oil level is low, and this can lead to accidents.

Always make sure that the oil level is correct. ◀

 The oil level varies with the temperature of the oil. The higher the temperature, the higher the level of oil in the sump.

Checking the oil level with the engine cold or after no more than a short ride will lead to misinterpretation; this in turn, means that the engine will be operated with the incorrect quantity of oil.

In order to ensure that the engine oil level is read correctly, check the oil level only after a lengthy trip. ◀

- Check that the engine is at operating temperature, make sure that the ground is level and firm and place the motorcycle on its stand.
- Wait five minutes after switching off the engine at operating temperature.
- Hold the motorcycle upright with OA Centre stand:
- Make sure the ground is level and firm and place the motorcycle on its centre stand. ◀

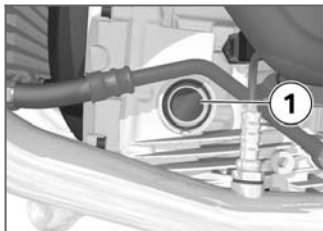

- Check the oil level in oil-level indicator **1**.

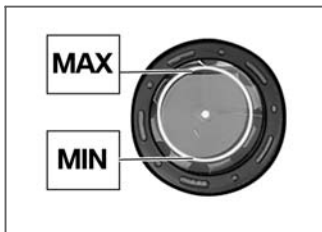

Engine oil level

– Between MIN and MAX marks



Engine oil level

– max 0.5 l (Difference between MIN and MAX)

If the oil level is below the MIN mark:

- Top up the engine oil (➔ 102)

If the oil level is above the MAX mark:

- Have the oil level corrected by a specialist workshop, preferably an authorised BMW Motorrad dealer.

### Topping up engine oil

- Check the engine oil level (➔ 101)



Damage to the engine can result if it is operated without enough oil, but the same also applies if the oil level is too high.

Always make sure that the oil level is correct. ◀

- Wipe the area around the filler neck clean.
- Use the tool from the toolkit to remove the cap from the filler neck.
- Top up the engine oil to the specified level.



Engine oil, quantity for topping up

– max 0.5 l (Difference between MIN and MAX)

- Use the tool from the toolkit to install the cap of the filler neck.

## Brake system, general

### Dependability of the brake system

A fully functional brake system is a basic requirement for the road safety of your motorcycle.

Do not ride the motorcycle if you have any doubts about the dependability of the brake system. Under these circumstances have the brake system checked by a specialist workshop, preferably an authorised BMW Motorrad dealer.



Incorrect working practices endanger the reliability of the brakes.

Have all work on the brake system performed by a specialist workshop, preferably an authorised BMW Motorrad dealer. ◀

### Checking operation of brakes

- Pull the handbrake lever.
    - » The pressure point must be clearly perceptible.
  - Press the footbrake lever.
    - » The pressure point must be clearly perceptible.
- If pressure points are not clearly perceptible:
- Have the brakes checked by a specialist workshop, preferably an authorised BMW Motorrad dealer.

## Brake pads

### Checking front brake pad thickness



Brake pads worn past the minimum permissible brake-pad thickness can cause a reduction in braking efficiency and under certain circumstances they can cause damage to the brake system.

In order to ensure the dependability of the brake system, do not permit the brake pads to wear past the minimum permissible brake-pad thickness. ◀

- Make sure the ground is level and firm and place the motorcycle on its stand.



- Visually inspect the left and right brake pads to ascertain their thickness. Viewing direction: Between wheel and fork tube toward the brake caliper.

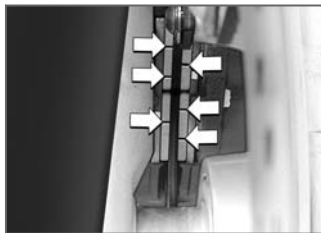

 Brake-pad wear limit, front

- min 1 mm (Friction pad only, without backing plate)
- The wear indicators (grooves) must be clearly visible.

If the wear indicating marks are no longer clearly visible:

- Have the brake pads replaced by a specialist workshop, preferably an authorised BMW Motorrad dealer.

## Checking rear brake pad thickness

 Brake pads worn past the minimum permissible brake-pad thickness can cause a reduction in braking efficiency and under certain circumstances they can cause damage to the brake system.

In order to ensure the dependability of the brake system, do not permit the brake pads to wear past the minimum permissible brake-pad thickness. ◀

- Make sure the ground is level and firm and place the motorcycle on its stand.

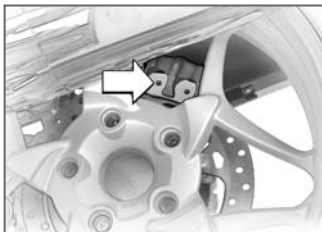

- Visually inspect the brake pads of the rear brake caliper from the left to ascertain their thickness.



Brake-pad wear limit, rear

- 1 mm (Friction pad only, without backing plate)
- Make sure that the brake disc is not visible through the bore in the inboard brake block.

Make sure that the brake disc is not visible through the bore in the inboard brake block.

- Have the brake pads replaced by a specialist workshop, preferably an authorised BMW Motorrad dealer.

## Brake-pad wear

The rear brake has a mechanical brake-pad wear indicator.

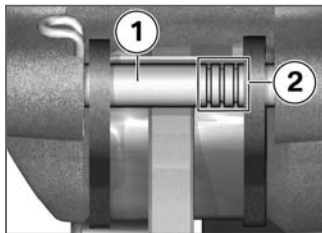

Shaft **1** with three marker rings **2** is between the brake pads.

## How to interpret the marks:

- Three rings visible: brake-pad thickness is at least 75 %
- Two rings visible: brake-pad thickness is at least 50 %
- One ring visible: brake-pad thickness is at least 25 %
- No rings visible: brake pads worn to wear limit; check as described above

## Brake fluid

### Checking brake-fluid level, front brakes



A low fluid level in the brake reservoir can allow air to penetrate the brake system. This significantly reduces braking efficiency.

Check the brake-fluid level at regular intervals. ◀

- Make sure the ground is level and firm and hold the motorcycle upright.

with OA Centre stand:

- Make sure the ground is level and firm and place the motor-cycle on its centre stand.<
- Move the handlebars to the straight-ahead position.



- Check the brake fluid level in front reservoir **1**.

▷ Wear of the brake pads causes the brake fluid level in the reservoir to sink.<



Brake fluid level, front

– DOT4 brake fluid

– Do not permit the brake fluid level to drop below the MIN mark. (Brake-fluid reservoir horizontal)

If the brake fluid level drops below the permitted level:

- Have the defect rectified as quickly as possible by a specialist workshop, preferably an authorised BMW Motorrad dealer.

## Checking brake-fluid level, rear brakes



A low fluid level in the brake reservoir can allow air to penetrate the brake system. This significantly reduces braking efficiency.

Check the brake-fluid level at regular intervals.<

- Make sure the ground is level and firm and hold the motor-cycle upright.
- with OA Centre stand:
- Make sure the ground is level and firm and place the motor-cycle on its centre stand.<



- Check the brake fluid level through aperture **A** in the right side panel.

▶ Wear of the brake pads causes the brake fluid level in the reservoir to sink.◀

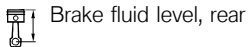
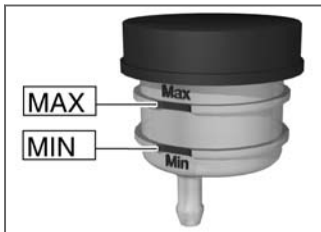

– DOT4 brake fluid

– Do not permit the brake fluid level to drop below the MIN mark. (Brake-fluid reservoir horizontal)

If the brake fluid level drops below the permitted level:

- Have the defect rectified as quickly as possible by a specialist workshop, preferably an authorised BMW Motorrad dealer.

## Clutch

### Checking clutch operation

- Pull the clutch lever.
    - » The pressure point must be clearly perceptible.
- If the pressure point is not clearly perceptible:

- Have the clutch checked by a specialist workshop, preferably an authorised BMW Motorrad dealer.

### Checking clutch fluid level

- Make sure the ground is level and firm and hold the motorcycle upright.  
with OA Centre stand:
- Make sure the ground is level and firm and place the motorcycle on its centre stand.◀
- Move the handlebars to the straight-ahead position.



- Check the clutch fluid level in reservoir **1**.

▶ Wear of the clutch causes the fluid level in the clutch fluid reservoir to rise.◀

▶ The clutch system is filled with a special hydraulic fluid that does not have to be changed.◀



– Do not permit the clutch fluid level to drop.

If the fluid level drops:

 Unsuitable hydraulic fluids could cause damage to the clutch system.

Do not attempt to top up the system with fluids of any kind.◀

- Have the defect rectified as quickly as possible by a specialist workshop, preferably

an authorised BMW Motorrad dealer.

## Tyres

### Measuring tread depth of tyres

 Your motorcycle's handling and grip can be impaired even before the tyres wear to the minimum tyre tread depth permitted by law.

Have the tyres changed in good time before they wear to the minimum permissible tread depth.◀

- Make sure the ground is level and firm and place the motorcycle on its stand.
- Measure the tyre tread depth in the main tread grooves with wear marks.

▶ Tyres have wear indicators integrated into the main tread grooves. The tyre is worn out when the tyre tread has worn

down to the level of the marks. The locations of the marks are indicated on the edge of the tyre, e.g. by the letters TI, TWI or by an arrow.◀

If the tyre tread no longer complies with the minimum legally required tread depth:

- Replace tyre.

## Rims

### Visual inspection

- Make sure the ground is level and firm and place the motorcycle on its stand.
- Visually inspect the rims for defects.
- Have damaged rims checked and, if necessary, replaced by a specialist workshop, preferably an authorised BMW Motorrad dealer.

## Wheels

### Recommended tyres

For each size of tyre BMW Motorrad tests and classifies as roadworthy certain makes. BMW Motorrad cannot assess the suitability or provide any guarantee of road safety for other tyres. BMW Motorrad recommends using only tyres tested by BMW Motorrad.

You can obtain detailed information from your authorised BMW Motorrad dealer or on the Internet at [www.bmw-motorrad.com](http://www.bmw-motorrad.com).

## RDC label<sup>OE</sup>

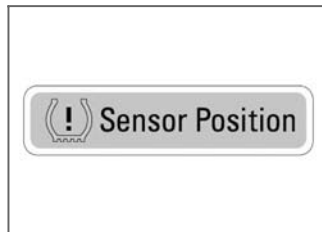

 Incorrect tyre-removal procedures can result in damage to the RDC sensors. Be sure to notify the authorised BMW Motorrad dealer or specialist workshop that the wheel is fitted with an RDC sensor.◀

If the motorcycle is equipped with RDC, each wheel rim bears an adhesive label indicating the position of the RDC sensor. When changing the tyre, take care not to damage the RDC sensor. Be sure to draw the attention of the authorised BMW

Motorrad dealer or specialist workshop to the fact that the wheel is fitted with an RDC sensor.

## Remove the front wheel

- Place the motorcycle on an auxiliary stand; BMW Motorrad recommends the BMW Motorrad rear-wheel stand.
- Install the rear-wheel stand (118) with OA Centre stand:
- Make sure the ground is level and firm and place the motorcycle on its centre stand.<

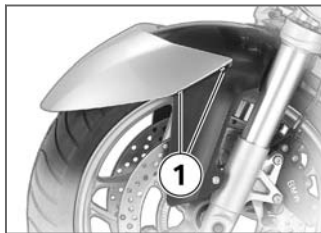

- Remove screws **1** on left and right.
- Lift the mudguard up and forward, pulling the two sides slightly apart.



 Once the calipers have been removed, there is a risk of the brake pads being pressed together to the extent that they cannot be slipped back over the brake disc on reassembly.

Do not operate the handbrake lever when the brake calipers have been removed.<

- Remove securing screws **2** of the left and right brake calipers.

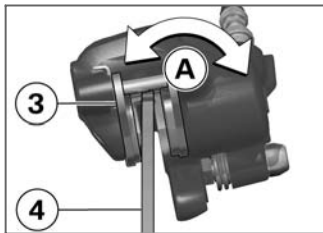

- Force the brake pads slightly apart by rocking brake calipers **3** back and forth **A** against brake discs **4**.
- Mask off the parts of the wheel rim that could be scratched in the process of removing the brake calipers.
- Carefully pull the brake calipers back and out until clear of the brake discs.

with OE BMW Motorrad Integral ABS:

- When removing the left brake caliper, take care not to damage the ABS sensor cable.<

- Raise front of motorcycle until the front wheel can turn freely. BMW Motorrad recommends the BMW Motorrad front-wheel stand for lifting the motorcycle.
- Install the front-wheel stand (▶▶ 117)

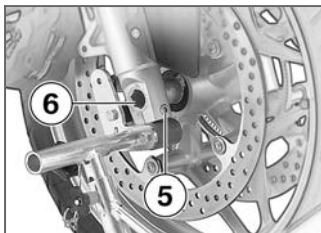

- Release axle clamping screw **5**.
- Remove quick-release axle **6**, while supporting the wheel.

▶ BMW Motorrad can supply an adapter for removing the quick-release axle. This adapter can be combined with any commercially available w/f 22 open-end or ring spanner. The BMW

special tool number is 363691 and the adapter is available from your authorised BMW Motorrad dealer.

The supplementary toolkit available as an optional accessory also includes a tool for removing the quick-release axle.<



- Roll the front wheel forward to remove.

with OE BMW Motorrad Integral ABS:

- Do not damage the ABS sensor on the left-hand side when rolling out the wheel.<

- Remove the spacing bushing from the left-hand side of the wheel hub.

## Installing front wheel

 Threaded fasteners not tightened to the specified torque can work loose or their threads can suffer damage. Always have the security of the fasteners checked by a specialist workshop, preferably an authorised BMW Motorrad dealer. ◀

 There is a risk of damaging parts of the front brake, particularly the BMW Integral ABS, in the course of the procedure described below. Take care not to damage the brake system, in particular the ABS sensor with cable and the ABS sensor ring. ◀

 The front wheel must be installed right way round to rotate in the correct direction. ◀

Note the direction-of-rotation arrows on the tyre or the wheel rim. ◀

- Slip the spacing bushing into the left-hand side of the wheel hub.



- Roll the front wheel into position between the front forks.

with OE BMW Motorrad Integral ABS:

- Do not damage the ABS sensor on the left-hand side when rolling in the wheel. ◀

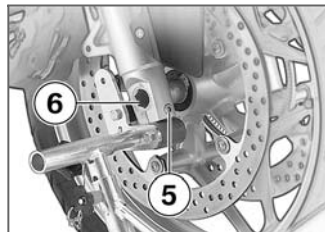

- Raise the front wheel, insert quick-release axle **6** and tighten to specified torque.



Quick-release axle in axle holder

– 50 Nm

- Tighten axle clamping screw **5** to the specified torque.



Quick-release axle clamp screws

– 19 Nm

- Remove the front-wheel stand.
- Slip the brake calipers onto the brake discs.

with OE BMW Motorrad Integral ABS:



 The cable of the ABS sensor could chafe through if it comes into contact with the brake disc.

Make sure that the ABS sensor cable is routed snugly along the front suspension. ◀

- Route ABS sensor cable **7** as illustrated here. ◀



- Install securing screws **2** and tighten to specified torque.



Brake caliper to slider tube

– 30 Nm

- Remove the adhesive tape from the wheel rim.

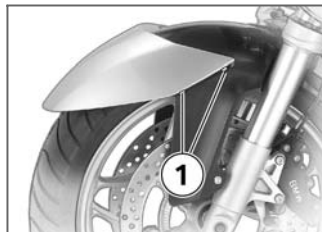

- Lower the mudguard into position from in front, noting the lug on the rear section of the mudguard.
- Install screws **1** on left and right.

 Braking efficiency is impaired if the brake pads are not correctly bedded against the discs.

Before riding off, always check that the brakes bite as soon as the brake lever is pulled or the brake pedal depressed. ◀

- Operate the brake several times until the brake pads are bedded.
- Remove the rear wheel stand, if installed beforehand.

## Removing rear wheel

**!** Parts of the exhaust system can be hot.

Do not touch hot parts of the exhaust system. ◀

- Place the motorcycle on an auxiliary stand; BMW Motorrad recommends the BMW Motorrad rear-wheel stand.
- Install the rear-wheel stand (➔ 118)

with OA Centre stand:

- Make sure the ground is level and firm and place the motorcycle on its centre stand. ◀

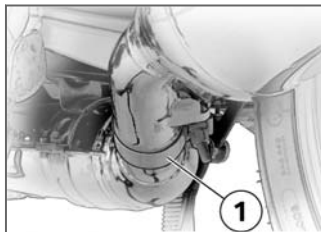

- Slacken clamp **1**.

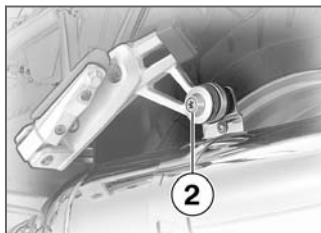

- Remove screw **2** for the bracket of the silencer from the rear footrest.



- Turn the silencer out.
- Engage first gear.

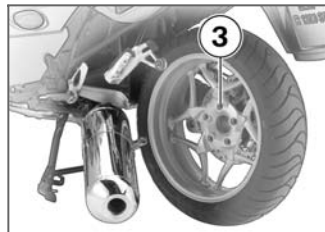

- Remove studs **3** from the rear wheel, while supporting the wheel.

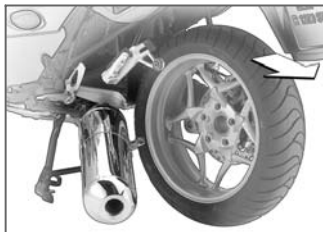

- Roll the rear wheel out toward the rear.

## Installing rear wheel

 Threaded fasteners not tightened to the specified torque can work loose or their threads can suffer damage. Always have the security of the fasteners checked by a specialist workshop, preferably an authorised BMW Motorrad dealer. ◀

- Check that the wheel centering spigot and contact surfaces of the wheel hub are free of grease.

- Insert the rear wheel into the centering hole.

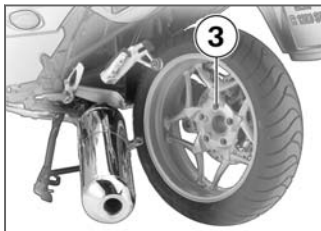

- Tighten screws **3** until hand-tight and then tighten to specified torque in diagonally opposite sequence.

 Rear wheel to wheel carrier

– Tightening sequence: tighten in diagonally opposite sequence

– 60 Nm



- Turn the silencer to its initial position.

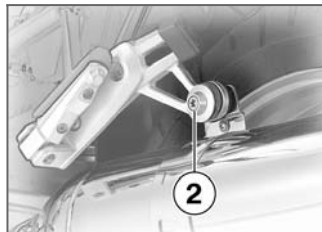

- Install screw **2** for the bracket of the silencer in the rear footrest, but do not tighten it at this point.

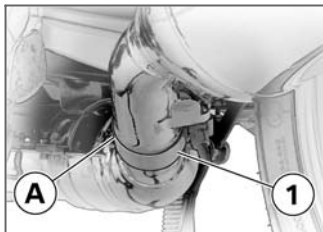

- Align clamp **1** on the silencer with mark **A** and tighten to specified torque.



Clamp to silencer and manifold

– 55 Nm

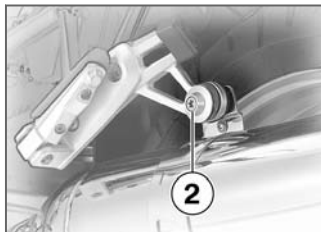

- ⚠ If the gap between the rear wheel and the silencer is too small, the rear wheel can overheat.

The gap between the rear wheel and the silencer must be at least 15 mm.◀

- Tighten screw **2** for the bracket of the silencer in the rear footrest to the specified torque.



Silencer to footrest system

– 19 Nm

- Remove the rear wheel stand, if installed beforehand.

## Front-wheel stand

### Use

A front-wheel stand for simple, safe changing of the front wheel is available from BMW Motorrad. You can obtain the front-wheel stand from your authorised BMW Motorrad dealer.



The BMW Motorrad front wheel stand is not designed to support motorcycles not fitted with a centre stand or without other auxiliary stands. A motorcycle resting only on the front wheel stand and the rear wheel can topple.

Place the motorcycle on its centre stand or another auxiliary stand before lifting the front wheel with the BMW Motorrad front-wheel stand.◀

## Installing front-wheel stand

- Place the motorcycle on an auxiliary stand; BMW Motorrad recommends the BMW Motorrad rear-wheel stand.
- Install the rear-wheel stand (➔ 118) with OA Centre stand:
- Make sure the ground is level and firm and place the motorcycle on its centre stand.◀

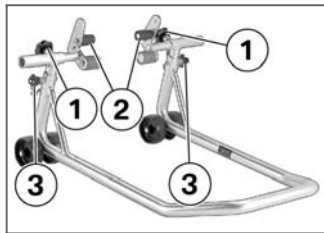

- Slacken adjusting screws **1**.

- Push the two adapters **2** apart until the front forks fit between them.
- Use locating pins **3** to set the front-wheel stand to the desired height.
- Centre the front-wheel stand relative to the front wheel and push it against the front axle.

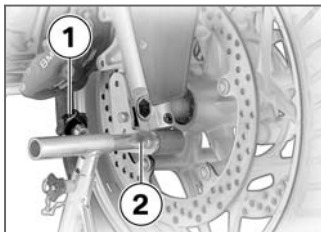

- Align the two adapters **2** so that the front forks are securely seated.
- Tighten adjusting screws **1**.



 If the motorcycle is on the centre stand and is raised too far, the centre stand will lift clear of the ground and the motorcycle could topple to one side. When raising the motorcycle, make sure that the centre stand remains on the ground.◀

- Apply uniform pressure to push the front-wheel stand down and raise the motorcycle.

## Rear-wheel stand

### Use

BMW Motorrad offers a rear-wheel stand for holding motorcycles (including those without centre stands) securely upright for maintenance work. You can obtain the rear-wheel stand from your authorised BMW Motorrad dealer.

### Installing rear-wheel stand

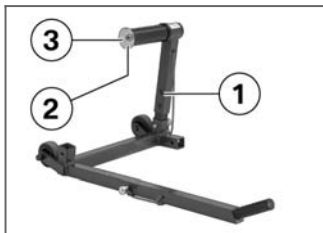

- Use screws **1** to set the rear-wheel stand to the desired height.

- Remove retaining disc **2**. To do so, press release button **3**.



- Push the rear-wheel stand from the right onto the rear axle.
- Push on retaining disc **2** from the left, while holding the unlock button down.
- Take a grip on the motorcycle with your left hand, and place your right hand on lever **4** of the rear-wheel stand.



- Lift the motorcycle upright, simultaneously pressing the lever down until the stand supports the motorcycle in the upright position.
- Press the lever down to the ground.

## Bulbs

### General instructions

A warning appears in the multi-function display if a bulb is defective. If the brake or rear light fails, the symbol is accompanied by the 'General' warning light, which lights up yellow. If the rear

light fails the second filament of the brake light shines at reduced brightness to double as a rear light. Even though you have this substitute rear light, the indicators in the display tell you that a bulb defect has occurred.

**!** A defective bulb places your safety at risk because it is easier for other users to oversee the motorcycle. Replace defective bulbs as soon as possible; always carry a complete set of spare bulbs if possible. ◀

**!** The bulb is pressurised and can cause injury if damaged. Wear protective goggles and gloves when changing bulbs. ◀

▷ The types of bulb fitted to your motorcycle are listed in the section entitled "Technical data". ◀

▷ Do not touch the glass of new bulbs with your fingers. Use a clean, dry cloth to hold the bulbs when handling them. Dirt deposits, in particular oil and grease, interfere with heat radiation from the bulb. This leads to overheating and shortens the bulb's operating life. ◀

### Replacing low-beam and high-beam headlight bulbs

**!** If it is not standing firmly, the motorcycle could topple in the course of the operations described below. Always make sure that the motorcycle is stable and firmly supported. ◀

- Make sure the ground is level and firm and place the motorcycle on its stand.
- Switch off the ignition.

▷ Turn the handlebars to the left to facilitate access. ◀

▷ The description below is for the bottom light, but it applies by analogy to the top light as well. ◀

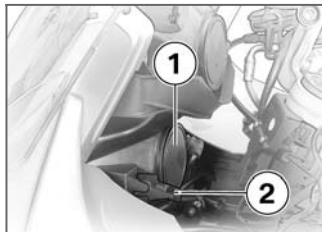

- Remove cover **1** by pulling bottom lever **2** (top headlight: lever points right).

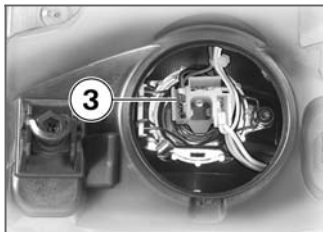

- Disconnect plug **3**.

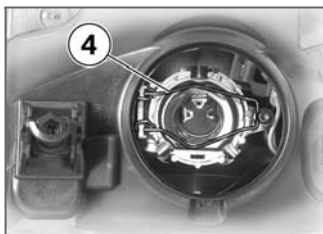

- Disengage spring clips **4** from the fastenings and swing them aside.

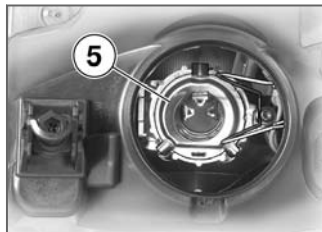

- Remove bulb **5**.
- Replace the defective bulb.



Bulb for low-beam and high-beam headlight

– H4 / 12 V / 55 W / 60 W

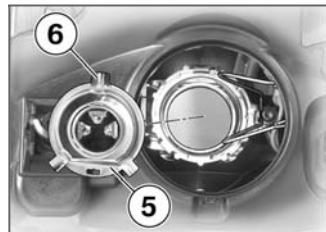

- Install bulb **5**. In this process, make sure that lug **6** is pointing up and that the bulb is securely seated.

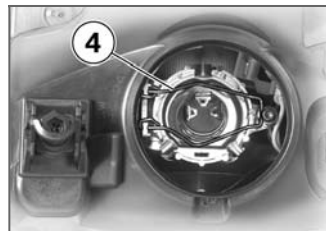

- Engage spring retainer **4** in the catches.

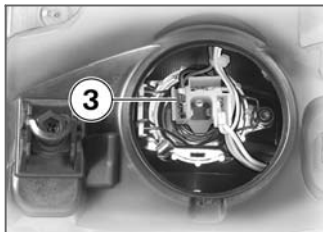

- Connect plug **3**.

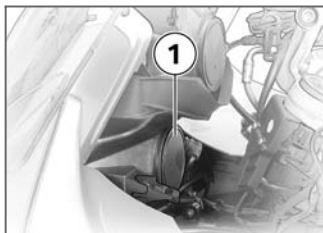

- Engage cover **1** at the top and press until seated.
- Check that the bulb is correctly seated (by looking in through the headlight lens).

## Replacing parking-light bulb

 If it is not standing firmly, the motorcycle could topple in the course of the operations described below. Always make sure that the motorcycle is stable and firmly supported. ◀

- Make sure the ground is level and firm and place the motorcycle on its stand.
- Switch off the ignition.

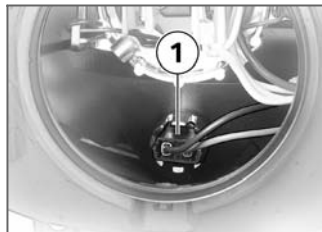

- Pull bulb socket **1** out of the housing of the bottom headlight.

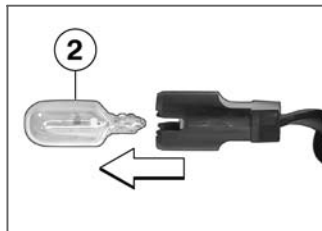

- Remove bulb **2** from the bulb holder.
- Replace the defective bulb



Bulb for parking light

- W5W / 12 V / 5 W

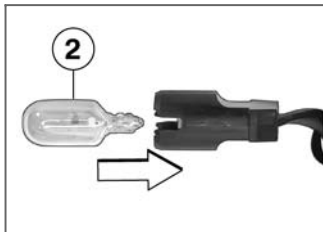

- Insert bulb **2** into the bulb socket.

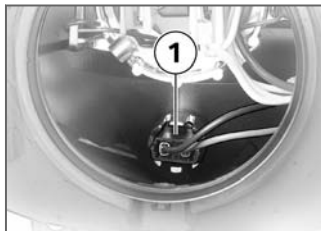

- Seat bulb socket **1** in the housing of the bottom headlight.

## Replacing the brake light and rear light bulbs

 If it is not standing firmly, the motorcycle could topple in the course of the operations described below.

Always make sure that the motorcycle is stable and firmly supported. ◀

- Switch off the ignition.
- Remove the rear seat (➡ 68)

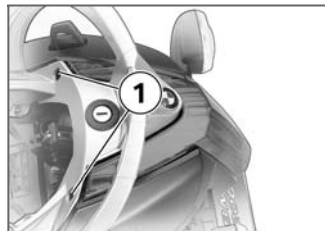

- Remove screws **1** on left and right.



- Pull bulb housing **2** to the rear to remove.

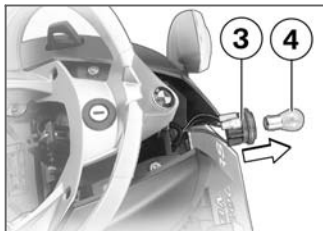

- Turn bulb holder **3** counter-clockwise to remove it from the bulb housing.
- Remove bulb **4** from the bulb socket.
- Install the rear seat (→ 69)
- Replace the defective bulb.

 Bulb for tail light/brake light

– P21/5W / 12 V / 5 W / 21 W

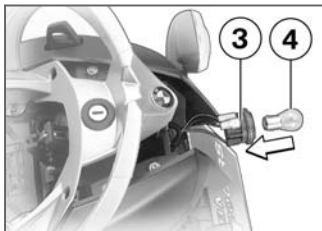

- Install bulb **4** in its socket.
- Turn bulb socket **3** clockwise and install it in the bulb housing.



- Install bulb housing **2**.



- Install screws **1** on left and right.

## Replacing front turn indicator bulb

 If it is not standing firmly, the motorcycle could topple in the course of the operations described below.

Always make sure that the motorcycle is stable and firmly supported. ◀

- Make sure the ground is level and firm and place the motorcycle on its stand.

- Switch off the ignition.



- Remove screw **1**.

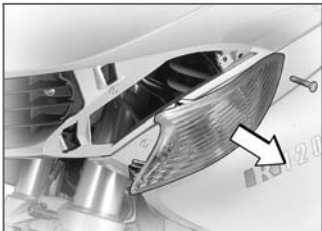

- Pull the turn indicator glass to the side to remove.

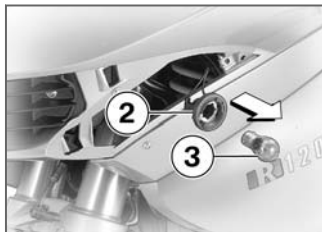

- Remove the bulb holder **2** from the bulb housing by turning it counter-clockwise.
- Remove the bulb **3** from the bulb holder.
- Replace the defective bulb.



Bulbs for flashing turn indicators, front

– PY21W / 12 V / 21 W

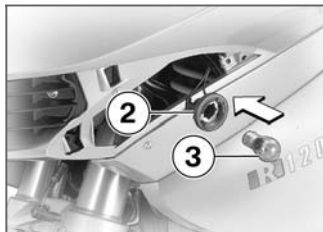

- Install bulb **3** in the bulb socket.
- Turn bulb socket **2** clockwise to install it in the bulb housing.



- Seat the turn indicator glass in the fairing.



- Install screw **1**.

## Replacing rear turn indicator bulb

 If it is not standing firmly, the motorcycle could topple in the course of the operations described below.

Always make sure that the motorcycle is stable and firmly supported. ◀

- Make sure the ground is level and firm and place the motorcycle on its stand.
- Switch off the ignition.

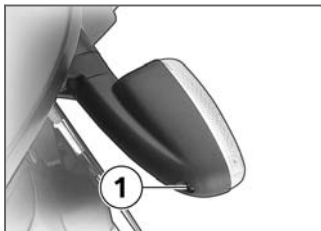

- Remove screw **1**.

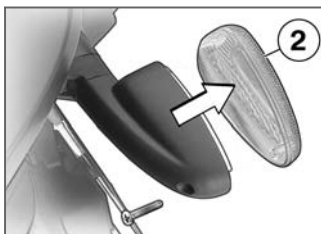

- Remove turn indicator glass **2**.

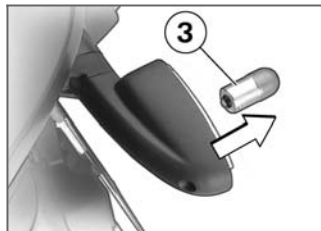

- Press bulb **3** into its socket and turn it counter-clockwise to remove.
- Replace the defective bulb.

 Bulbs for flashing turn indicators, rear

– RY10W / 12 V / 10 W

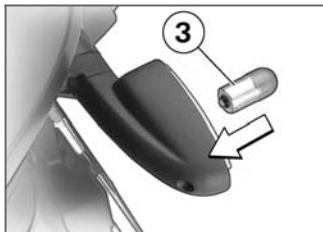

- Install bulb **3** in its socket.

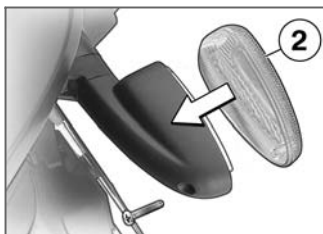

- Position turn indicator glass **2** on the turn indicator housing.

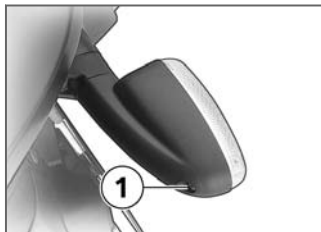

- Install screw **1**.

## Jump starting

 The wires leading to the power socket do not have a load-capacity rating adequate for jump-starting the engine. Excessively high current can lead to a cable fire or damage to the vehicle electronics.

Do not use the on-board socket to jump-start the engine of the motorcycle. ◀

 Touching live parts of the ignition system with the

engine running can cause electric shock.

Do not touch parts of the ignition system when the engine is running. ◀

 A short-circuit can result if the crocodile clips of the jump leads are accidentally brought into contact with the motorcycle.

Use only jump leads fitted with fully insulated crocodile clips at both ends. ◀

 Jump-starting with a donor-battery voltage higher than 12 V can damage the vehicle electronics.

Make sure that the battery of the donor vehicle has a voltage rating of 12 V. ◀

- Switch off the ignition.
- Remove the front seat (➔ 68)
- Remove the seat supporting rod.

- When jump-starting the engine, do not disconnect the battery from the on-board electrical system.
- Remove the protective cap from the battery's positive terminal.
- Run the engine of the donor vehicle during jump-starting.
- Begin by connecting one end of the red jump lead to the positive terminal of the discharged battery and the other end to the positive terminal of the donor battery.
- Then connect one end of the black jump lead to the negative terminal of the donor battery, and the other end to the negative terminal of the discharged battery.
- Start the engine of the vehicle with the discharged battery in the usual way; if the engine does not start, wait a few minutes before repeating the

attempt in order to protect the starter motor and the donor battery.

- Allow both engines to idle for a few minutes before disconnecting the jump leads.
- Disconnect the jump lead from the negative terminals first, then disconnect the second lead from the positive terminals.

 Do not use proprietary start-assist sprays or other products to start the engine.◀

- Install the seat supporting rod.
- Install the front seat (➡ 69)

## Battery

### Maintenance instructions

Correct upkeep, recharging and storage will prolong the life of the battery and are essential if warranty claims are to be considered.

Compliance with the points below is important in order to maximise battery life:

- Keep the surface of the battery clean and dry
- Do not open the battery
- Do not top up with water
- Be sure to read and comply with the instructions for charging the battery on the following pages
- Do not turn the battery upside down

 If the battery is not disconnected, the on-board electronics (e.g. clock, etc.) gradually drain the battery. This can cause the battery to run flat. If this happens, warranty claims will not be accepted.

If the motorcycle is to be out of use for more than four weeks, disconnect the battery or connect a suitable trickle charger to the battery.◀

 BMW Motorrad has developed a float charger specially designed for compatibility with the electronics of your motorcycle. Using this charger, you can keep the battery charged during long periods of disuse, without having to disconnect the battery from the motorcycle's on-board systems. You can obtain additional information from your authorised BMW Motorrad dealer. ◀

### Charging battery when connected

 Charging the connected battery directly at the battery terminals can damage the vehicle electronics. Always disconnect the battery from the on-board circuits before recharging it with a charger connected directly to the battery posts. ◀

 Only chargers suitable for this mode of charging can be used to recharge the battery via the on-board socket. Unsuitable chargers could cause damage to the motorcycle's on-board electrics. Use BMW chargers with the part numbers 71 60 7 688 864 (220 V) or, as applicable, 71 60 7 688 865 (110 V). If you are in doubt, disconnect the battery from the on-board systems and connect the charger directly to the battery. ◀

 If you switch on the ignition and the multifunction display and telltale lights fail to light up, the battery is completely flat. Attempting to charge a completely flat battery via the on-board socket can cause damage to the motorcycle's electronics. If a battery has discharged to the extent that it is completely flat, it has to be disconnected from the

on-board circuits and charged with the charger connected directly to the battery posts. ◀

- Charge via the power socket, with the battery connected to the motorcycle's on-board electrical system.
- Comply with the operating instructions of the charger.

 The motorcycle's on-board electronics know when the battery is fully charged. The on-board socket is switched off when this happens. ◀

### Charging battery when disconnected

- Charge the battery using a suitable charger.
- Comply with the operating instructions of the charger.
- Once the battery is fully charged, disconnect the charger's terminal clips from the battery terminals.

▶ The battery has to be recharged at regular intervals in the course of a lengthy period of disuse. See the instructions for caring for your battery. Always fully recharge the battery before restoring it to use ◀

## Removing battery

- Switch off the ignition.
- Remove the front seat (→ 68)

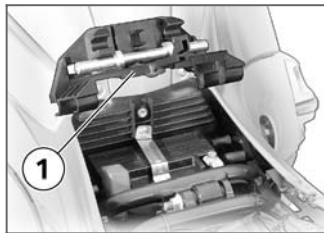

- Remove seat supporting rod **1**.

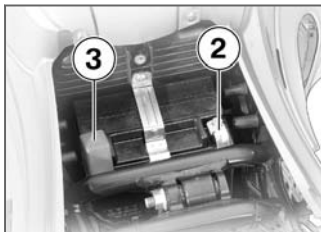

**!** Disconnection in the wrong sequence increases the risk of short-circuits. Always proceed in the correct sequence. ◀

- Disconnect negative lead **2** first.
- Then pull back protective cap **3** and disconnect the positive cable.

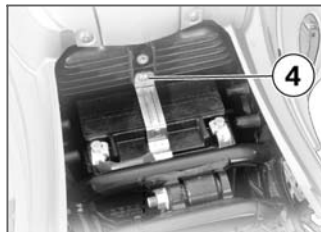

- Remove screw **4** and remove the battery retainer.
- Lift the battery up and out; work it slightly back and forth if it is difficult to remove.

## Install the battery

- Switch off the ignition.
- Insert the battery into the battery compartment, with the positive terminal on the left in the forward direction of travel.



- Slip the battery retainer over the battery and install screw **4**.

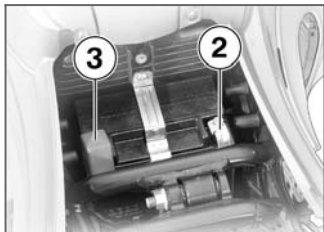

-  Installation in the wrong sequence increases the risk of short-circuits.



Always proceed in the correct sequence.  
Never install the battery without the protective cap. ◀

- Connect the positive lead to the positive terminal.
- Install protective cap **3**.
- Connect negative lead **2** to the negative terminal.

 If the battery was disconnected from the motorcycle for a prolonged period of time it will be necessary to enter the current date in the instrument cluster, in order to ensure that the service-due indicator functions correctly.

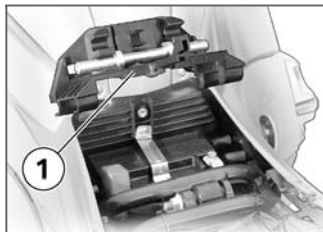
If you want to have the date set consult a specialist workshop, preferably an authorised BMW Motorrad dealer. ◀



- Install seat supporting rod **1**.
- Install the front seat (  69)
- Set the clock (  46)

## Care

Care products .....	132
Washing motorcycle .....	132
Cleaning easily damaged components.....	132
Paint care .....	133
Protective wax coating .....	134
Laying up the motorcycle .....	134
Restoring motorcycle to use .....	134

## Care products

BMW Motorrad recommends that you use the cleaning and care products you can obtain from your authorised BMW Motorrad dealer. The substances in BMW Care Products have been tested in laboratories and in practice; they provide optimised care and protection for the materials used in your vehicle.

 The use of unsuitable cleaning and care products can damage vehicle components. Do not use solvents such as cellulose thinners, cold cleaners, fuel or the like, and do not use cleaning products that contain alcohol.◀

## Washing motorcycle

BMW Motorrad recommends that you use BMW insect remover to soften and wash off insects and stubborn dirt on

painted parts prior to washing the motorcycle.

To prevent stains, do not wash the motorcycle immediately after it has been exposed to strong sunlight and do not wash it in the sun.

Make sure that the motorcycle is washed frequently, especially during the winter months.

To remove road salt, clean the motorcycle with cold water immediately after every trip.

 After the motorcycle has been washed, ridden through water or ridden in the rain, the brake discs and pads might be wet and the brakes might not take effect immediately.

Apply the brakes in good time until the brakes have dried out.◀

 Warm water intensifies the effect of salt.

Use only cold water to wash off road salt.◀

 The high pressure of steam cleaners can damage seals, the hydraulic brake system, the electrical system, and the seat. Do not use a steam jet or high-pressure cleaning equipment.◀

## Cleaning easily damaged components

### Plastics

Clean plastic parts with water and BMW plastic care emulsion. This includes in particular:

- Windscreen and slipstream deflectors
- Headlight lens made of plastic
- Glass cover of the instrument cluster
- Black, unpainted parts

 If plastic parts are cleaned using unsuitable cleaning

agents, the surfaces can be damaged.

Do not use cleaning agents that contain alcohol, solvents or abrasives to clean plastic parts.

Even fly-remover pads or cleaning pads with hard surfaces can produce scratches.◀

 Soften stubborn dirt and insects by covering the affected areas with a wet cloth.◀

## Windscreen

Clean off dirt and insects with a soft sponge and plenty of water.

 Fuel and chemical solvents attack the material of the windscreen; the windscreen becomes opaque or dull.

Do not use cleaning agents.◀

## Chrome

Use plenty of water and BMW shampoo to clean chrome, particularly if it has been exposed to road salt. Use chrome polish for additional treatment.

## Radiator

Clean the radiator regularly to prevent overheating of the engine due to inadequate cooling. For example, use a garden hose with low water pressure.

 Cooling fins can be bent easily.

Take care not to bend the fins when cleaning the radiator.◀

## Rubber

Treat rubber components with water or BMW rubber-care products.

 Using silicone sprays for the care of rubber seals can cause damage.

Do not use silicone sprays or other care products that contain silicon.◀

## Paint care

Washing the motorcycle regularly will help counteract the long-term effects of substances that damage the paint, especially if your motorcycle is ridden in areas with high air pollution or natural sources of dirt, for example tree resin or pollen.

Remove particularly aggressive substances immediately, however, as otherwise the paint can be affected or become discoloured. Substances of this nature include spilt fuel, oil, grease, brake fluid and bird droppings. We recommend BMW vehicle polish or BMW paint cleaner for this purpose.

Marks on the paintwork are particularly easy to see after the motorcycle has been washed.

Remove stains of this kind immediately, using cleaning-grade benzene or petroleum spirit on a clean cloth or ball of cotton wool. BMW Motorrad recommends BMW tar remover for removing specks of tar. Remember to wax the parts treated in this way.

## Protective wax coating

BMW Motorrad recommends applying only BMW car wax or products containing carnauba wax or synthetic wax.

It is time to rewax the paint-work when water "puddles" on the surface, instead of forming beads.

## Laying up the motorcycle

- Clean the motorcycle.
- Remove the battery.
- Spray the brake and clutch lever pivots, the side stand

pivots and the centre stand pivots (if the motorcycle is fitted with a centre stand) with a suitable lubricant.

- Coat bright metal and chrome-plated parts with an acid-free grease (e.g. Vaseline).
- Stand the motorcycle in a dry room in such a way that there is no load on either wheel.

 Before laying the vehicle up out of use, have the engine oil and the oil filter element changed by a specialist workshop, preferably an authorised BMW Motorrad dealer. Combine work for laying up/restoring to use with a BMW service or inspection.◀

## Restoring motorcycle to use

- Remove the protective wax coating.
- Clean the motorcycle.

- Install a charged battery.
- Before starting: work through the checklist.

## Technical data

Troubleshooting chart .....	136
Threaded fasteners .....	137
Engine .....	139
Fuel.....	140
Engine oil .....	140
Clutch .....	141
Transmission .....	142
Rear-wheel drive.....	142
Running gear .....	143
Brakes .....	144
Wheels and tyres .....	144
Electrics .....	146
Frame .....	148
Dimensions .....	148
Weights.....	149

Riding specifications .....	149
-----------------------------	-----

## Troubleshooting chart

Engine does not start at all or is difficult to start.

<b>Possible cause</b>	<b>Remedy</b>
Kill switch activated	Kill switch in operating position
Side stand extended and gear engaged	Retract the side stand. (➡ 74)
Gear engaged and clutch not disengaged	Select neutral or pull clutch lever (➡ 74)
Clutch pulled when ignition was OFF	Switch on the ignition, then pull the clutch lever
No fuel in tank	Refuelling (➡ 80)
Battery not adequately charged	Charge the battery when connected (➡ 128)

## Threaded fasteners

Front wheel	Value	Valid
<b>Brake caliper to slider tube</b>		
M8 x 32 - 10.9	30 Nm	
<b>Quick-release axle clamp screws</b>		
M8 x 35	19 Nm	
<b>Quick-release axle in axle holder</b>		
M24 x 1.5	50 Nm	
Rear wheel	Value	Valid
<b>Rear wheel to wheel carrier</b>		
M10 x 40 x 1.25	<b>tighten in diagonally opposite sequence</b>	
	60 Nm	
<b>Silencer to footrest system</b>		
M8 x 35	19 Nm	
<b>Clamp to silencer and manifold</b>		
M8	55 Nm	

<b>Mirror arm</b>	<b>Value</b>	<b>Valid</b>
<b>Mirror to clamping piece</b>		
M10	25 Nm	
<b>Clamping piece to clamping block</b>		
	10 Nm	
<b>Handlebars</b>	<b>Value</b>	<b>Valid</b>
<b>Stub handlebar to slider tube</b>		
M8 x 25	19 Nm	

## Engine

Engine design	four-stroke opposed twin, air-cooled with oil-cooled exhaust ports, installed longitudinally, two overhead camshafts, electronic engine management
Displacement	1170 cm <sup>3</sup>
Cylinder bore	101 mm
Piston stroke	73 mm
Compression ratio	12.0:1
Nominal output	81 kW, Over: 7500 min <sup>-1</sup>
with OE Power reduction:	74 kW, Over: 7500 min <sup>-1</sup>
Torque	115 Nm, Over: 6000 min <sup>-1</sup>
Maximum engine speed	max 8000 min <sup>-1</sup>
Idle speed	1150±50 min <sup>-1</sup>

## Fuel

Recommended fuel grade	98 ROZ/RON, Premium plus unleaded 95 ROZ/RON, Premium unleaded (fuel grade, usable with power- and consumption-related restrictions)
Usable fuel capacity	21 l
Reserve fuel	≥4 l

## Engine oil

Engine oil, capacity	max 4 l, with filter change
Lubricant	Engine oil, 20W-50
Engine oil, quantity for topping up	max 0.5 l, Difference between MIN and MAX
Oil consumption	1 l/1000 km
Oil grades	Engine oils of API classification SF or better. Engine oils of ACEA classification A2 or better. BMW Motorrad recommends not using synthetic oils for the first 10,000 km. Please do not hesitate to contact your authorised BMW Motorrad dealer if you have any questions relating the choice of a suitable engine oil for your motorcycle.

**Permissible viscosity classes**

SAE 5 W- $\geq 30$	-20...20 °C, Operation at low temperatures
SAE 10 W-40	-10...30 °C, Operation at moderate temperatures
SAE 15 W- $\geq 40$	$\geq 0$ °C
SAE 20 W- $\geq 40$	$\geq 0$ °C
SAE 5 W- $\geq 50$	$\geq -20$ °C, High-grade and synthetic oils, operation in all temperature ranges
SAE 10 W- $\geq 50$	$\geq -20$ °C, High-grade and synthetic oils, operation in all temperature ranges

**Clutch**

Clutch type	Single-plate dry clutch
-------------	-------------------------

## Transmission

Gearbox type	Helical 6-speed gearbox with integral reaction damper, claw-action shift by sliding sleeves
Gearbox transmission ratios	1.824 (31:17 teeth), Primary transmission ratio 2.277 (41:18 teeth), 1st gear 1.583 (38:24 teeth), 2nd gear 1.259 (34:27 teeth), 3rd gear 1.033 (31:30 teeth), 4th gear 0.903 (28:31 teeth), 5th gear 0.805 (29:36 teeth), 6th gear

## Rear-wheel drive

Type of final drive	Shaft drive with bevel gears
Type of rear suspension	BMW EVO Paralever; cast light-alloy single swinging arm with two joints and torque reaction link
Gear ratio of final drive	2.62:1

## Running gear

Type of front suspension	BMW Telelever, leading link pivot-mounted on engine and telescopic forks, central spring strut supported by leading link and main frame
Spring travel, front	110 mm, At wheel
Type of rear suspension	Central spring strut with single-tube gas-filled shock absorber, steplessly adjustable rebound damping and hydraulically adjustable spring preload
with OE Electronic Suspension Adjustment (ESA):	Central spring strut with single-tube gas-filled shock absorber, electrically adjustable rebound damping with three settings and electro-hydraulically adjustable spring preload with three settings
Spring travel at rear wheel	140 mm

## Brakes

Type of front brake	hydraulically operated twin disc brake with 4-piston fixed calipers and floating brake discs
Brake-pad material, front	Sintered metal
Type of rear brake	Hydraulically operated disc brake with 2-piston floating caliper and fixed disc
Brake-pad material, rear	Organic material

## Wheels and tyres

Tyre combinations recommended at time of going to press (As at: 24.04.2007)	Front: Bridgestone Battlax BT020F CC Radial SE, 120/55 ZR17 M/C (58W) Rear: Bridgestone Battlax BT020R AARadial SE, 180/55 ZR17 M/C (73W)
	Front: Continental Conti Road Attack Z, 120/55 ZR17 M/C (58W) Rear: Continental Conti Road Attack C, 180/55 ZR17 M/C (73W)
	Front: Continental Conti Road Attack C, 120/55 ZR17 M/C (58W) Rear: Continental Conti Road Attack C, 180/55 ZR17 M/C (73W)

	Front: Dunlop D220F ST P, 120/55 ZR17 M/C (58W) Rear: Dunlop D220 ST P, 180/55 ZR17 M/C (73W)
	Front: Metzeler Roadtec Z6 Front, 120/55 ZR17 M/C (58W) Rear: Metzeler Roadtec Z6 C, 180/55 ZR17 M/C (73W)
	Front: Metzeler Sporttec M-1B, 120/55 ZR17 M/C (58W) Rear: Metzeler Sporttec M-1B, 180/55 ZR17 M/C (73W)
	Front: Michelin Pilot Road B F TL, 120/70 ZR17 M/C (58W) Rear: Michelin, Pilot Road K TL, 180/55 ZR17 M/C (73W)

### Front wheel

Front wheel, type	Cast wheel with 5 double spokes, MT H2
Front wheel rim size	3.50" x 17"
Tyre designation, front	120/70 ZR17

**Rear wheel**

Rear wheel type	Cast wheel with 5 double spokes, MT H2
Rear wheel rim size	5.50" x 17"
Tyre designation, rear	180/55 ZR17

**Tyre pressures**

Tyre pressure, front	2.2 bar, one-up, tyre cold 2.5 bar, two-up and/or with luggage, tyre cold
Tyre pressure, rear	2.5 bar, one-up, tyre cold 2.9 bar, two-up and/or with luggage, tyre cold

**Electrics**

Electrical rating of on-board socket	5 A, Per on-board socket
with OA Extra socket:	5 A, Total for all sockets
Fuses	All circuits are electronically protected, so plug-in fuses are no longer necessary. If an electronic fuse trips and de-energises a circuit, the circuit is active as soon as the ignition is switched on after the fault has been rectified.

**Battery**

Battery type	AGM (Absorptive Glass Mat) battery
Battery rated voltage	12 V
Battery rated capacity	14 Ah

**Spark plugs**

Spark plugs, manufacturer and designation	Bosch YR5LDE NGK DCPR 8 EKC
Electrode gap of spark plug	0.8 $\pm$ 0.1 mm, When new max 1 mm, Wear limit
Secondary spark plugs, manufacturer and designation	Bosch YR5LDE NGK DCPR 8 EKC
Electrode gap of secondary spark plug	0.8 $\pm$ 0.1 mm, When new max 1 mm, Wear limit

**Lighting**

Bulb for low-beam and high-beam headlight	H4 / 12 V / 55 W / 60 W
Bulb for parking light	W5W / 12 V / 5 W
Bulb for tail light/brake light	P21/5W / 12 V / 5 W / 21 W
Bulbs for flashing turn indicators, front	PY21W / 12 V / 21 W
Bulbs for flashing turn indicators, rear	RY10W / 12 V / 10 W

## Frame

Frame type	Tubular steel front frame with tubular steel rear frame, load-bearing drive unit
Type plate location	Rear frame, centre, under rear seat
VIN location	Front frame top centre

## Dimensions

Length of motorcycle	2165 mm
Height of motorcycle	1220 mm, In DIN normal-load position; without mirrors, windscreen lowered
Width of motorcycle	750 mm, Width across handlebars without mirrors
Front-seat height	810...830 mm, At unladen weight
with OE Front seat, low:	780...800 mm

## Weights

Unladen weight	229 kg, DIN unladen weight, ready for road 90 % load of fuel, without optional extras
Permissible gross weight	460 kg
Maximum payload	231 kg

## Riding specifications

Top speed	>200 km/h
-----------	-----------



## Service

BMW Motorrad service .....	152
BMW Motorrad service quality .....	152
BMW Motorrad Service Card: on-the-spot breakdown assistance ....	152
BMW Motorrad service network ...	153
Maintenance work .....	153
Confirmation of maintenance work .....	154
Confirmation of service .....	159

## BMW Motorrad service

Advanced technology requires specially adapted methods of maintenance and repair.



If maintenance and repair work is performed inexpertly, it could result in consequential damage and thus constitute a safety risk.

BMW Motorrad recommends you to have all the associated work on your motorcycle carried out by a specialist workshop, preferably an authorised BMW Motorrad dealer. ◀

Your authorised BMW Motorrad dealer can provide information on BMW services and the work undertaken as part of each service. Have all maintenance and repair work carried out confirmed in the "Service" chapter in this manual. Authorised BMW Motorrad dealers are supplied with the latest technical information and have

the necessary technical know-how. BMW Motorrad recommends that you contact your authorised BMW Motorrad dealer if you have questions regarding your motorcycle.

## BMW Motorrad service quality

Along with its reputation for engineering quality and high reliability, BMW Motorrad is a byword for excellent quality of service. To ensure that your BMW is always in optimum condition, BMW Motorrad recommends that you have the maintenance work required for your motorcycle carried out regularly, preferably by your authorised BMW Motorrad dealer. For generous treatment of claims submitted after the warranty period has expired, evidence of regular maintenance is essential.

Certain signs of wear, moreover, may otherwise not be noticed until it is too late to put them right at moderate cost. Your authorised BMW Motorrad dealer's mechanics know every detail of your motorcycle and can take remedial action if necessary before minor faults develop into serious problems. By having the necessary repairs done properly and in good time, you save time and money in the long run.

## BMW Motorrad Service Card: on-the-spot breakdown assistance

In the event of a breakdown, the BMW Motorrad Service Card issued with each new BMW motorcycle enables you to access an extensive range of services such as breakdown assistance, motorcycle transportation etc. (details can differ from country to country). In the event of a break-

down, contact the Mobile Service organisation of BMW Motorrad. The specialists will provide the necessary advice and assistance. You will find important country-specific contact addresses and the after-sales service organisation phone numbers in the "Service Kontakt / Service Contact" brochures, along with information on Mobile Service and the dealership network.

## **BMW Motorrad service network**

BMW Motorrad has an extensive after-sales service network in place to look after you and your motorcycle in more than 100 countries. In Germany alone, you have the best possible access to approximately 200 authorised BMW Motorrad dealers. All information concerning the international dealership network can be found in the brochure

"Service Contact Europe" or "Service Contact Africa, America, Asia, Australia, Oceania".

## **Maintenance work**

### **BMW Pre-delivery Check**

Your authorised BMW motorcycle dealer conducts the BMW pre-delivery check before handing over the motorcycle to you.

### **BMW Running-in Check**

The BMW running-in check has to be performed when the motorcycle has covered between 500 km and 1,200 km

### **BMW Service**

The BMW Service is carried out once a year; the extent of servicing can vary, depending on the age of the motorcycle and the distance it has covered. Your authorised BMW Motorrad dealer confirms that the service work has been carried out and enters

the date when the next service will be due.

Riders who cover long distances in a year might have to bring in their motorcycles for service before the next scheduled date. It is to allow for these cases that a maximum odometer reading is entered as well in the confirmation of service. Servicing has to be brought forward if this odometer reading is reached before the next scheduled date for the service.

The service-due indicator in the multifunction display reminds you about one month or 1000 km in advance when the time for a service is approaching, on the basis of the programmed values.

## Confirmation of maintenance work

### BMW Pre-delivery Check

Completed

on \_\_\_\_\_

\_\_\_\_\_  
Stamp, signature

### BMW Running-in Check

Completed

on \_\_\_\_\_

Odometer reading \_\_\_\_\_

Next service  
at the latest on

on \_\_\_\_\_

or, if logged beforehand,

Odometer reading \_\_\_\_\_

\_\_\_\_\_  
Stamp, signature

**BMW Service**

Completed

on \_\_\_\_\_

Odometer reading \_\_\_\_\_

Next service

at the latest on

on \_\_\_\_\_

or, if logged beforehand,

Odometer reading \_\_\_\_\_

\_\_\_\_\_  
Stamp, signature**BMW Service**

Completed

on \_\_\_\_\_

Odometer reading \_\_\_\_\_

Next service

at the latest on

on \_\_\_\_\_

or, if logged beforehand,

Odometer reading \_\_\_\_\_

\_\_\_\_\_  
Stamp, signature**BMW Service**

Completed

on \_\_\_\_\_

Odometer reading \_\_\_\_\_

Next service

at the latest on

on \_\_\_\_\_

or, if logged beforehand,

Odometer reading \_\_\_\_\_

\_\_\_\_\_  
Stamp, signature

**BMW Service**

Completed

on \_\_\_\_\_

Odometer reading \_\_\_\_\_

Next service

at the latest on

on \_\_\_\_\_

or, if logged beforehand,

Odometer reading \_\_\_\_\_

\_\_\_\_\_  
Stamp, signature**BMW Service**

Completed

on \_\_\_\_\_

Odometer reading \_\_\_\_\_

Next service

at the latest on

on \_\_\_\_\_

or, if logged beforehand,

Odometer reading \_\_\_\_\_

\_\_\_\_\_  
Stamp, signature**BMW Service**

Completed

on \_\_\_\_\_

Odometer reading \_\_\_\_\_

Next service

at the latest on

on \_\_\_\_\_

or, if logged beforehand,

Odometer reading \_\_\_\_\_

\_\_\_\_\_  
Stamp, signature

**BMW Service**

Completed

on \_\_\_\_\_

Odometer reading \_\_\_\_\_

Next service

at the latest on

on \_\_\_\_\_

or, if logged beforehand,

Odometer reading \_\_\_\_\_

\_\_\_\_\_  
Stamp, signature**BMW Service**

Completed

on \_\_\_\_\_

Odometer reading \_\_\_\_\_

Next service

at the latest on

on \_\_\_\_\_

or, if logged beforehand,

Odometer reading \_\_\_\_\_

\_\_\_\_\_  
Stamp, signature**BMW Service**

Completed

on \_\_\_\_\_

Odometer reading \_\_\_\_\_

Next service

at the latest on

on \_\_\_\_\_

or, if logged beforehand,

Odometer reading \_\_\_\_\_

\_\_\_\_\_  
Stamp, signature

**BMW Service**

Completed

on \_\_\_\_\_

Odometer reading \_\_\_\_\_

Next service

at the latest on

on \_\_\_\_\_

or, if logged beforehand,

Odometer reading \_\_\_\_\_

\_\_\_\_\_  
Stamp, signature**BMW Service**

Completed

on \_\_\_\_\_

Odometer reading \_\_\_\_\_

Next service

at the latest on

on \_\_\_\_\_

or, if logged beforehand,

Odometer reading \_\_\_\_\_

\_\_\_\_\_  
Stamp, signature**BMW Service**

Completed

on \_\_\_\_\_

Odometer reading \_\_\_\_\_

Next service

at the latest on

on \_\_\_\_\_

or, if logged beforehand,

Odometer reading \_\_\_\_\_

\_\_\_\_\_  
Stamp, signature

## Confirmation of service

The table is intended as a record of maintenance, warranty and repair work, the installation of optional accessories and, if appropriate, special campaign (recall) work.

Item	Odometer reading	Date



## A

Abbreviations and symbols, 6

### ABS

Self-diagnosis, 75

Warning, 32

### Accessories

General instructions, 92

Anti-theft alarm, 18

Warning, 39

### ASC

Self-diagnosis, 76

Switching off, 58

Switching on, 58

Warning, 34

## B

Battery, 15

Charging battery when connected, 128

Charging battery when disconnected, 128

Installation, 129

Maintenance instructions, 127

Removal, 129

Warning for battery charge current, 27

BMW Motorrad service, 152

BMW Motorrad Service

Card, 152

### Brake fluid

Checking level, front, 13, 105

Checking level, rear, 13, 106

### Brake pads

Checking front, 103

Checking, rear, 104

Running in, 77

### Brakes

Adjusting handbrake lever, 60

Checking operation, 103

Technical data, 144

### Bulbs

General instructions, 118

Replacing front turn indicator bulb, 123

Replacing low-beam and high-beam headlight bulbs, 119

Replacing rear turn indicator bulb, 125

Replacing side-light bulb, 121

Replacing the brake light and rear light bulbs, 122

Technical data, 147

Warning for bulb failure, 27, 28

## C

### Case

Closing, 94

Installing, 95

Opening, 94

Removing, 95

### Centre stand

Placing motorcycle on centre stand, 80

Removing motorcycle from centre stand, 80

Checklist, 73

### Clock

Adjusting, 18, 46

### Clutch

Adjusting clutch lever, 60

Checking level, 11, 107

Checking operation, 107

Technical data, 141

Confirmation of maintenance work, 154

Currency, 7

**D**

- Damping
  - Adjusting, 11, 63

**E**

- Electrics
  - Technical data, 146
- Emergency off switch (kill switch), 17, 57
- Engine
  - Technical data, 139
  - Warning for engine electronics, 26
- Engine oil
  - Checking level, 11, 101
  - Temperature gauge, 22
  - Topping up, 11, 102
  - Warning for engine oil level, 30
  - Warning for engine oil pressure, 26
- Equipment, 7
- ESA, 16, 64
- EWS, 45
  - Warning, 26

**F**

- Frame
  - Technical data, 148
- Front-wheel stand, 116
- Fuel
  - Quantity reading, 22
  - Refuelling, 80
  - Warning for fuel down to reserve, 26
- Fuses, 146

**G**

- Gear indicator, 22
- Grip heating, 17, 57

**H**

- Handlebar fittings
  - General view, left side, 16
  - General view, right side, 17
- Handlebars
  - Adjusting handlebar height, 11
- Hazard warning flashers, 16
  - Switching off, 56
  - Switching on, 56

**Headlight**

- Adjustment for driving on left/  
driving on right, 67
  - Beam throw, 11, 67
  - High-beam headlight, 19
  - Low-beam headlight, 19
  - Side light, 19
- Headlight flasher, 16
  - Helmet holder, 15, 70
  - High-beam headlight, 16
  - Horn, 16

**I**

- Ignition
  - Switching off, 44
  - Switching on, 44
- Immobiliser, 45
  - Warning, 26
- Instrument cluster
  - Overview, 18
  - Sensor for instrument-cluster lighting, 18

**J**

- Jump starting, 126

## **K**

Keys, 44, 46

## **L**

Laying up, 134

Lights

- Headlight flasher, 54
- High-beam headlight, 54
- Low-beam headlight, 54
- Parking light, 55
- Side light, 54

Luggage

- Correct loading, 93

## **M**

Maintenance

- General instructions, 100

Mirrors

- Adjusting, 61

Motorcycle

- General view, left side, 11
- General view, right side, 13
- Laying up, 134
- Restoring to use, 134

Multifunction display

- Overview, 22

## **O**

Odometer and tripmeters

- Resetting, 48
- Selecting readings, 47

On-board computer

- Ambient temperature, 50
- Average consumption, 51
- Average speed, 51
- Oil level, 53
- Range, 52
- Selecting readings, 50

## **P**

Power socket, 11

Pre-ride check, 75

## **R**

Rear-wheel drive

- Technical data, 142

Rear-wheel stand, 118

Refuelling, 80

Reserve

- Warning, 26

Residual range, 49

Restoring to use, 134

Rev. counter, 18

Running gear

- Technical data, 143

## **S**

Seat

- Adjust the seat height, 59
- Install the front seat, 69
- Install the rear seat, 69
- Lock, 13
- Remove the front seat, 68
- Remove the rear seat, 68

Service, 152

- Status indicators on the display, 22

Service Card, 152

Side stand

- For starting, 74
- Placing motorcycle on side stand, 79
- Removing motorcycle from side stand, 79

Spark plugs

- Technical data, 147

Speedometer, 18

Spring preload  
  Adjusting, 11, 62

Starter, 17

Steering lock  
  Locking, 45

**T**

Technical data

- Brakes, 144
- Bulbs, 147
- Clutch, 141
- Electrics, 146
- Engine, 139
- Frame, 148
- Rear-wheel drive, 142
- Running gear, 143
- Spark plugs, 147
- Standards, 7
- Transmission, 142
- Wheels and tyres, 144

Telltale lights, 18

Toolkit

- Service kit, 100
- Standard equipment, 100

Topcase

- Closing, 96
- Installing, 97
- Opening, 96
- Removing, 97

Torques, 137

Transmission

- For starting, 74
- Technical data, 142

Troubleshooting chart, 136

Turn indicators

- Left, 16, 55
- Right, 17, 55
- Switching off, 17, 56

Type plate, 15

Tyre pressure monitoring RDC

- Label on wheel rim, 109
- Status indicators, 53
- Warning, 34, 37, 38

Tyres

- Air-pressures table, 15
- Checking inflation pressure, 66
- Recommended tyres, 109
- Running in, 77
- Technical data, 144

**V**

Vehicle identification number, 13

**W**

Warning lights, 18

Warnings

- Mode of presentation, 24

Warnings, overview, 25, 29, 31, 33, 36, 40

Wheels

- Installing front wheel, 112
- Installing rear wheel, 115
- Remove the front wheel, 110
- Removing rear wheel, 114
- Technical data, 144

Windscreen

- Adjusting, 11, 59

Details described or illustrated in this booklet may differ from the motorcycle's actual specification as purchased, the accessories fitted or the national-market specification. No claims will be entertained as a result of such discrepancies.

Dimensions, weights, fuel consumption and performance data are quoted to the customary tolerances.

The right to modify designs, equipment and accessories is reserved.

Errors and omissions excepted.

© 2007 BMW Motorrad

Not to be reproduced either wholly or in part without written permission from BMW Motorrad, After Sales.

Printed in Germany.

## Important data for refuelling

<b>Fuel</b>	
Recommended fuel grade	98 ROZ/RON, Premium plus unleaded 95 ROZ/RON, Premium unleaded (fuel grade, usable with power- and consumption-related restrictions)
Usable fuel capacity	21 l
Reserve fuel	≥4 l
<b>Tyre pressures</b>	
Tyre pressure, front	2.2 bar, one-up, tyre cold 2.5 bar, two-up and/or with luggage, tyre cold
Tyre pressure, rear	2.5 bar, one-up, tyre cold 2.9 bar, two-up and/or with luggage, tyre cold

**BMW recommends** 

Order No. 01 41 7 712 061  
07.2007, 4th edition

